

# PERFLUOROCTANOIC ACID

## 1. Exposure Data

### 1.1 Identification of the agent

#### 1.1.1 Nomenclature

*Chem. Abstr. Serv. Reg. No.:* 335-67-1

*Chem. Abstr. Serv. Name:* Perfluorooctanoic acid

*IUPAC Name:* 2,2,3,3,4,4,5,5,6,6,7,7,8,8,8-pentadecafluorooctanoic acid

*Synonyms:* PFOA; pentadecafluoro-1-octanoic acid; pentadecafluoro-n-octanoic acid; pentadecafluorooctanoic acid; perfluorocaprylic acid; perfluorooctanoic acid; perfluoroheptanecarboxylic acid; APFO; ammonium perfluorooctanoate

*Isomers and Salts:* There are 39 possible structural isomers of pentadecafluorooctanoic acid (1 with chain length 8, 5 with chain length 7, 13 with chain length 6, 16 with chain length 5, and 4 with chain length 4). These isomers can also exist as the ammonium, sodium, or potassium salt (Nielsen, 2012). Fig. 1.1 presents the few isomers and salts that have Chemical Abstracts Service (CAS) references.

#### 1.1.2 Structural and molecular formulae, and relative molecular mass: straight-chain isomer

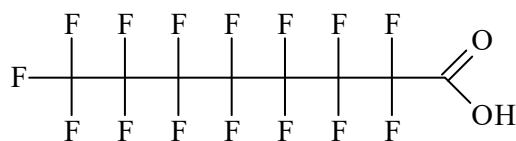

Molecular formula:  $C_8HF_{15}O_2$

Relative molecular mass: 414

#### 1.1.3 Chemical and physical properties of the pure substance: straight-chain isomer

From [HSDB \(2014\)](#), unless otherwise indicated

*Description:* White to off-white powder

*Boiling point:* 192.4 °C

*Melting point:* 54.3 °C

*Density:* 1.792 g/cm<sup>3</sup> at 20 °C







*Solubility:* 9.5 g/L in water at 25 °C

*Vapour pressure:* 0.0023 kPa at 20 °C (extrapolated); 0.127 kPa at 59.25 °C (measured) ([ATSDR, 2009](#)); 0.070 kPa at 25 °C

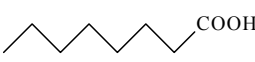
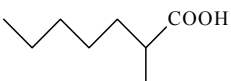
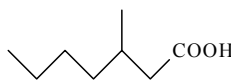
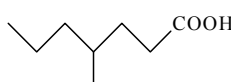
*Stability:* When heated to decomposition it emits toxic vapours of hydrogen fluoride

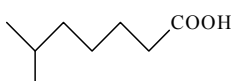
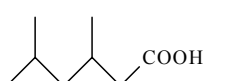
*Conversion factor:* Assuming normal temperature (25 °C) and pressure (101 kPa), 1 mg/m<sup>3</sup> = 16.9 ppm.

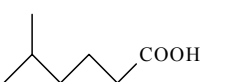
**Fig. 1.1 Structures of isomers and salts of perfluorooctanoic acid (PFOA)****a. PFOA isomers**

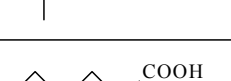
Carbon chain length and structure	CAS registry number
8 	335-67-1
7 	207678-51-1
7 	705240-04-6
7 	1144512-18-4
7 	909009-42-3
7 	15166-06-0
6 	1144512-35-5
6 	1192593-79-5
6 	1144512-36-6
6 	1144512-34-4
6 	35605-76-6

**b. Ammonium salts of PFOA isomers**

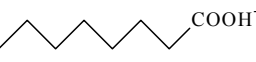
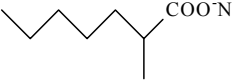
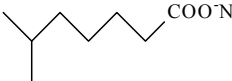
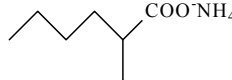
Carbon chain length and structure	CAS registry number
8 	3825-26-1
7 	207678-62-4
7 	19742-57-5
6 	13058-06-5

**c. Sodium salts of PFOA isomers**

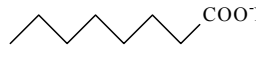
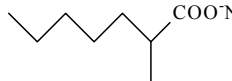
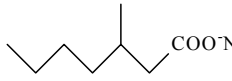
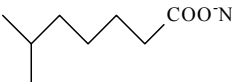
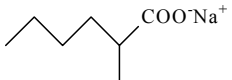
Carbon chain length and structure	CAS registry number
8 	335-95-5
7 	207678-72-6
7 	646-84-4
7 	18017-22-6
6 	1195164-59-0

**d. Potassium salts of PFOA isomers**

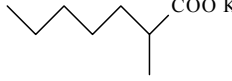
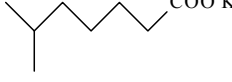
Carbon chain length and structure	CAS registry number
8 	2395-00-8
7 	207678-65-7
7 	29457-73-6

Adapted from [Nielsen \(2012\)](#)  
CAS, Chemical Abstracts Service

**Table 1.1 Selected methods for the analysis of perfluorooctanoic acid (PFOA)**

Sample matrix	Sample preparation	Assay procedure	Limit of detection	Reference
Drinking-water	Adsorb on polystyrene divinylbenzene; elute methanol; reconstitute in water/methanol with <sup>13</sup> C-PFOA internal standard	HPLC-MS/MS	1.7 ng/L	<a href="#">EPA (2009a)</a> Method 537-1
Indoor and outdoor air	Collect particle-bound PFOA on glass fibre filters; elute methanol	HPLC-TOF/MS	1 pg/m <sup>3</sup>	<a href="#">Barber et al. (2007)</a>
Human serum	Precipitate proteins with formic acid; solid phase extraction clean-up	HPLC-MS/MS	0.1 ng/mL	<a href="#">Kuklenyik et al. (2005)</a>
Human milk	Precipitate proteins with formic acid; solid phase extraction clean-up	HPLC-MS/MS	0.2 ng/mL	<a href="#">Kuklenyik et al. (2004)</a>
Animal tissue	Add homogenized tissue to buffered tetra-n-butylammonium hydrogensulfate solution; Extract with <i>tert</i> -butyl methyl ether	HPLC-TOF/MS	1.25 ng/g ww	<a href="#">Berger &amp; Haukås (2005)</a>
Soil	Rehydrate soil to ~50% moisture; extract with acetonitrile/water; sonicate and centrifuge; decant supernatant	HPLC-MS/MS	180 fg on column	<a href="#">Washington et al. (2008)</a>
Foods and food packaging	Methanol extraction	HPLC-MS/MS	0.5 ng/g ww	<a href="#">Tittlemeier et al. (2007)</a>

HPLC-MS/MS, high-performance liquid chromatography-mass spectrometry/mass spectrometry; MS, mass spectrometry; TOF, time-of-flight mass spectrometry; ww, wet weight

### 1.1.4 Technical products and impurities

See [Fig. 1.1](#)

Perfluorooctanoic acid (PFOA) produced by the electrochemical fluorination (ECF) method, before 2002, was reported to have a consistent isomer composition of 78% linear isomer (standard deviation, 1.2%) and 22% branched-chain isomer (standard deviation, 1.2%) in 18 production lots over a 20-year period, as determined by <sup>19</sup>F nuclear magnetic resonance. PFOA produced by the telomerization method (major use from 2002 to present) is typically an isomerically pure, linear product ([Benskin et al., 2010](#)).

PFOA produced by ECF was reported to contain the following impurities: perfluorohexanoate, 0.73%; perfluoroheptanoate, 3.7%; perfluorononanoate, 0.2%; perfluorodecanoate, 0.0005%; perfluoroundecanoate, 0.0008%; and perfluorododecanoate, 0.0008% ([Benskin et al., 2010](#)).

### 1.1.5 Analysis

Selected methods for the analysis of PFOA in various matrices are listed in [Table 1.1](#). Methods for the trace analysis of PFOA in human serum and milk, in food and consumer products, as well as in environmental samples such as wildlife, water, solid matrices, and air have been reviewed ([ATSDR, 2009](#); [Jahnke & Berger, 2009](#)).

## 1.2 Production and use

### 1.2.1 Production process

Perfluoroalkyls have been manufactured industrially by two methods: electrochemical fluorination (ECF) and telomerization. The two techniques can be distinguished based on the isomeric profile of their products. ECF (major use from the 1950s to 2002) results in a product containing both linear and branched isomers, while telomerization (major use from 2002 to

**Table 1.2 Production volumes for perfluorooctanoic acid (PFOA) in the USA, 1986–2002**

Substance produced	Production volume range (pounds)				
	1986	1990	1994	1998	2002
Perfluorooctanoic acid	10 000–500 000	Not reported	10 000–500 000	10 000–500 000	10 000–500 000
Ammonium perfluorooctanoate	10 000–500 000	10 000–500 000	10 000–500 000	10 000–500 000	500 000–1 000 000

From [ATSDR \(2009\)](#); reported under the United States Environmental Protection Agency Inventory Update Rule

Note: 10 000–500 000 pounds corresponds to approx. 4.5–227 tonnes; and 500 000–1 000 000 pounds corresponds to approx. 227–454 tonnes

present) typically yields an isomerically pure, linear product ([ATSDR, 2009](#)).

During the ECF process, an organic acyl backbone structure is dissolved in a solution of aqueous hydrogen fluoride. A direct electrical current is then passed through the solution, which replaces all of the hydrogens on the molecule with fluorines. Perfluoroacyl fluorides produced by ECF are hydrolysed to form the perfluorocarboxylic acid, which is then separated via distillation ([ATSDR, 2009](#)).

From 1947 until 2002, ECF was used worldwide to manufacture most (80–90% in 2000) PFOA, as the ammonium salt. The largest production sites were in the USA and Belgium, the next largest were in Italy, and small-scale producers were located in Japan. From about 1975 to the present, the remaining 10–20% of ammonium perfluorooctanoate was manufactured by direct oxidation of perfluorooctyl iodide at one site in Germany, and at least one site in Japan. In 1999, the global annual production of ammonium perfluorooctanoate was approximately 260 tonnes. By 2002, the principal worldwide manufacturer of ammonium perfluorooctanoate using ECF had discontinued external sales and ceased production, leaving only a few relatively small producers in Europe and in Asia ([Prevedouros et al., 2006](#)). Production volumes of PFOA, as both the acid and the ammonium salt, in the USA from 1986 to 2002 are shown in [Table 1.2](#).

The telomerization process begins with the preparation of pentafluoroiodoethane from tetrafluoroethane. Tetrafluoroethane is then

added to the product at a molar ratio that gives a product of desired chain length, and the final product is oxidized to form the carboxylic acid. The telomerization process produces linear perfluorocarboxylic acids with even numbers of carbon atoms ([ATSDR, 2009](#)).

New production capacity for ammonium perfluorooctanoate based on perfluorooctyl iodide commenced in the USA in late 2002. In 2006, the eight major manufacturers of PFOA in the USA joined the 2010/2015 PFOA Stewardship Program, a voluntary programme run by the United States Environmental Protection Agency (EPA) with the aim of reducing facility emissions and product content of PFOA, its precursors, and higher homologues by 95% by 2010, compared with the year 2000 ([EPA, 2014](#)). These manufacturers also agreed to the goal of totally eliminating these substances from emissions and product contents by 2015. Six of the eight manufacturers reported at least 95% reduction in emissions of PFOA by the end of 2010 in the USA. Substantial reductions in product content were also reported by these manufacturers for 2010 relative to 2000, both in the USA and in global operations. In a few cases, data were withheld by the manufacturers to protect business interests – particularly for non-USA operations and for precursors ([EPA, 2014](#)). Ammonium perfluorooctanoate is currently manufactured in Japan via oxidation of a mixture of linear fluorotelomer olefins ([Prevedouros et al., 2006](#)).

### 1.2.2 Uses

PFOA and its salts have been used as emulsifiers to solubilize fluoromonomers and to facilitate their aqueous polymerization in the production of fluoropolymers such as polytetrafluoroethylene and fluoroelastomers, used as non-stick coatings on cookware, membranes for clothing that are both waterproof and breathable, electrical-wire casing, fire- and chemical-resistant tubing, and plumber's thread-seal tape ([ATSDR, 2009](#)). Fluoropolymer manufacture is the single largest direct use of the ammonium salts of PFOA ([Prevedouros et al., 2006](#)).

PFOA has also been used in cosmetics, greases and lubricants, paints, polishes, adhesives, and fluorinated surfactants ([HSDB, 2014](#)). Widespread use of perfluorocarboxylates, including PFOA, and derivatives as additives in industrial and consumer products in 1966 included metal cleaners, electrolytic-plating baths, self-shine floor polishes, cement, fire-fighting formulations, varnishes, emulsion polymerization, lubricants, gasoline, and paper, leather, and textile treatments ([Prevedouros et al., 2006](#)). PFOA has found use as a grease and water-repellent coating in food packaging ([Fromme et al., 2009](#)).

Perfluorocarboxylates, including PFOA, were used as a component in aqueous fire-fighting foam from about 1965 to 1975. These formulations were used by the military (e.g. at aircraft bases and aboard ship) and in oil and gas production, refining industries, and airports worldwide ([Prevedouros et al., 2006](#)).

## 1.3 Occurrence and exposure

### 1.3.1 Environmental occurrence

The sources of emissions of PFOA to the environment are: (a) their manufacture, use and disposal; (b) their presence as impurities in substances that are emitted to the environment;

and (c) precursor substances that degrade abiotically or biotically in the environment ([Buck et al., 2011](#)). One reference defined all chemicals with a C<sub>7</sub>F<sub>15</sub> or C<sub>8</sub>F<sub>17</sub> perfluorinated alkyl moiety and a direct bond to any chemical moiety other than a fluorine, chlorine, or bromine atom, as potential precursors of PFOA ([Environment Canada, 2012](#)). For example, 8:2 polyfluoroalkyl phosphates have been measured in human serum and can be metabolized to 8:2 fluorotelomer alcohol (8:2 FTOH) and/or PFOA in animal models ([Lee & Mabury, 2011](#); [Environment Canada, 2012](#)). However, the extent to which the various precursors are metabolized in humans, and their relative contribution to serum concentrations of PFOA, are not well understood.

Under normal environmental conditions, PFOA is highly persistent, with photodegradation and hydrolysis half-lives of months to years, and insignificant biotic degradation ([Environment Canada, 2012](#)). It has low to moderate potential to accumulate in aquatic species, but does appear to accumulate in some terrestrial and marine mammals ([Environment Canada, 2012](#)).

#### (a) Natural occurrence

PFOA is not known to occur naturally.

#### (b) Air

Although PFOA is not routinely monitored in air, sporadic measurements have been reported. [Fromme et al. \(2009\)](#) reviewed the literature and reported site mean concentrations of PFOA in air ranging from 1.4 to 552 pg/m<sup>3</sup> from 11 rural and urban outdoor sampling sites in Japan, Canada, the United Kingdom, Norway, Ireland, and the USA; the highest measurements were from urban locations or adjacent to busy roads. PFOA and 8:2 FTOH have been found in remote Arctic areas far from known sources, suggesting long-range aerial transport. Concentrations of PFOA ranging from 0.012 to 0.147 ng/L were reported in polar ice caps in the High Arctic in 2006 ([Environment Canada, 2012](#)).

*(c) Water*

Samples from potable water supplies without known point sources of perfluorooctanoate contamination typically contain perfluorooctanoate at < 1 ng/L, or at levels below the detection limit ([Fromme et al., 2009](#)). However, higher concentrations in drinking-water have been reported for some locations. For example, [Kim et al. \(2011b\)](#) reported average concentration of perfluorooctanoate of 5.4 ng/L, and a maximum concentration of 33 ng/L, for 15 tap-water samples collected in 8 cities in the Republic of Korea. Surface water from Boulder basin of Lake Mead, the Hoover dam, and the lower Colorado River in the USA had average concentrations of perfluorooctanoate that were below the method reporting limit of 5 ng/L; however, samples affected by run-off from municipal wastewater treatment facilities had average concentrations of perfluorooctanoate ranging from 26 to 120 ng/L ([Quiñones & Snyder, 2009](#)).

Concentrations of perfluorooctanoate in water were measured in six public-water districts and for selected private wells in West Virginia, USA; these concentrations differed substantially by water district, varying by about three orders of magnitude ([Fig. 1.2](#); [Shin et al., 2011a](#)). Perfluorooctanoate has also been measured at concentrations exceeding 1 ng/L in many of more than 8000 samples of surface water and groundwater collected in the region surrounding a large fluoropolymer-production facility in West Virginia, USA, probably due to direct emissions to the Ohio River, the air, and long-term transport through the vadose zone ([DuPont, 2010](#)). The highest off-site environmental concentrations of PFOA were predicted to occur about 1 mile [1.6 km] away from the production facility, and average concentrations in drinking-water ranged from < 0.05 to 10.1 µg/L in 2002–2004 ([Paustenbach et al., 2007](#)).

*(d) Food*

PFOA may be found in food due to contamination of plants and animals, and/or via transfer from food-packaging materials. [Trudel et al. \(2008\)](#) summarized several studies reporting measurements of PFOA in food in North America and Europe. Among the food categories, snacks and potatoes were reported to have the highest concentrations of PFOA (up to 3 ng/g wet weight), followed by packaged cereal products, meat, and North American fish/shellfish (up to 0.5, 1.0, and 2.0 ng/g, respectively). A list of measurements of PFOA concentrations in various foods is provided in [Table 1.3](#).

*(e) Dust*

[Trudel et al. \(2008\)](#) and [Fromme et al. \(2009\)](#) reviewed the literature and estimated the concentrations of PFOA in dust in typical indoor environments as 100 ng/g and 19.72 ng/g, respectively.

Several studies suggested that the potential contribution of dust ingestion to exposure was higher than previously estimated. For example, one study in the USA reported a median concentration of PFOA in dust of 142 ng/g, and a 95th percentile of 1200 ng/g in dust collected at 102 homes and 10 day-care centres in Ohio and North Carolina, USA, in 2000–2001 ([Strynar & Lindstrom, 2008](#)). A study of 102 homes in Vancouver, Canada, reported median concentrations of 30 ng/g for PFOA in dust, 63 ng/g for 8:2 FTOH, and 1362 ng/g for the sum of polyfluoroalkyl phosphoric acid diesters containing at least one 8:2 polyfluoroalkyl group, suggesting that these potential precursors may contribute substantially to the body burden of PFOA if efficiently metabolized in the human body ([De Silva et al., 2012](#)).

*1.3.2 Occupational exposure*

In occupational settings, the primary routes of exposure are thought to be dermal and by inhalation ([IFA, 2014](#)). Studies of occupational

**Fig. 1.2 Measured and modelled concentrations of perfluorooctanoic acid (PFOA) in water for the six public water districts in the C8 Health Project/C8 Science Panel studies, USA**

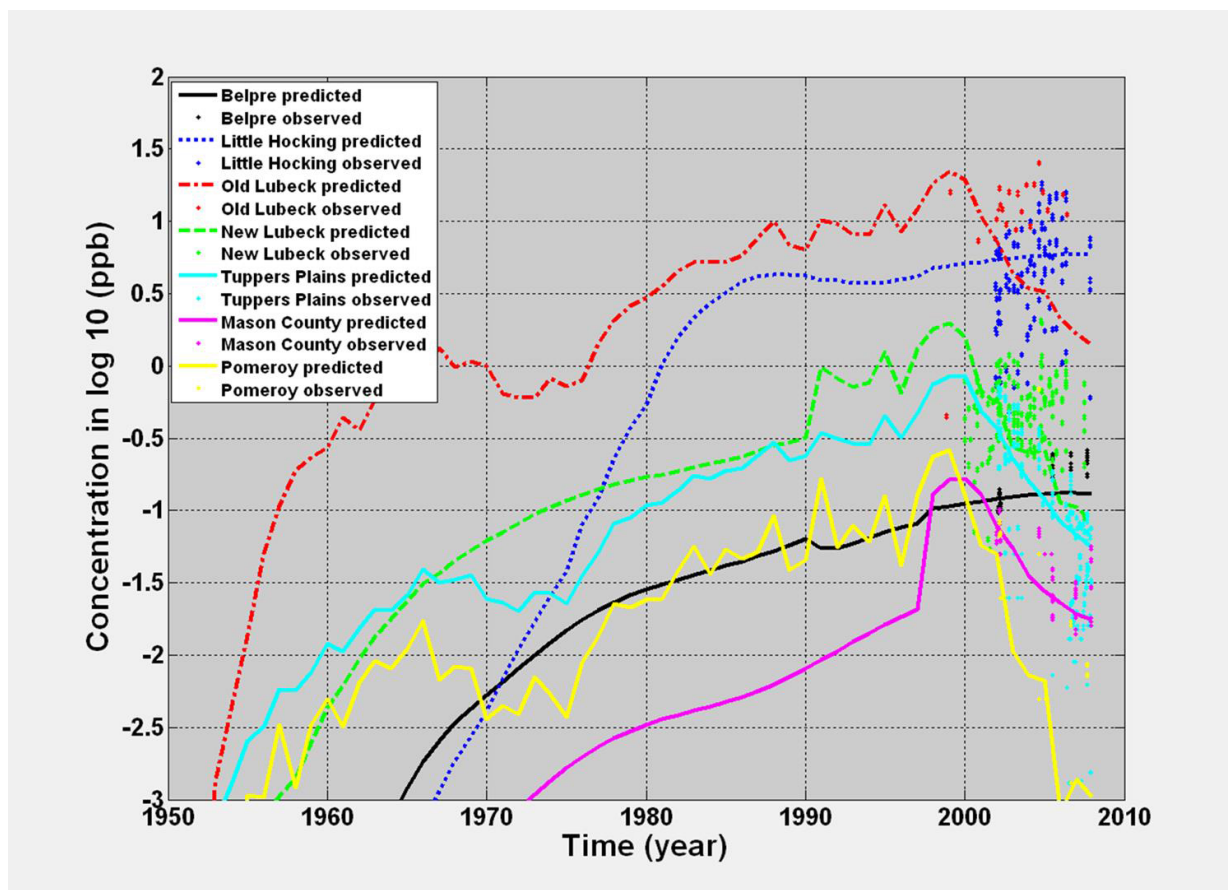

For the Lubeck water district, different well locations were used before 1991 ("Old Lubeck") and after 1991 ("New Lubeck")

ppb, parts per billion

Reprinted with permission from Shin HM, Vieira VM, Ryan PB et al. Environmental fate and transport modelling for perfluorooctanoic acid emitted from the Washington Works Facility in West Virginia. *Environmental Science and Technology*, Volume 45, pages 1435–1442. Copyright (2011) American Chemical Society ([Shin et al., 2011a](#))

exposure have typically described exposures to ammonium perfluorooctanoate, a salt of PFOA that is often produced in industry ([Lundin et al., 2009](#); [Woskie et al., 2012](#)).

[Woskie et al. \(2012\)](#) summarized measurements of ammonium perfluorooctanoate in 2125 blood samples collected from workers in a fluoropolymer-production facility in West Virginia, USA, in 1972–2004; there was a peak in median serum concentrations in 2000 that exceeded 1000  $\mu\text{g/L}$  in most highly exposed groups when PFOA was at the point of highest

use. In 2000–2004, median serum concentration of perfluorooctanoate among these workers was 240  $\mu\text{g/L}$ . Measured serum concentrations were paired with work histories to construct a model predicting serum concentration by job-exposure group from 1950 to 2004; in most years, the highest exposures were predicted for operators exposed to the fine powder or granular polytetrafluoroethylene chemical, for whom the predicted serum perfluorooctanoate concentration peaked in 1980, exceeding 6000  $\mu\text{g/L}$ , and declined to about 2000  $\mu\text{g/L}$  in 2004. Predicted

**Table 1.3 Concentrations of perfluorooctanoic acid (PFOA) in food and drinking-water**

Food category	Concentration (ng/g wet weight)	Year of sampling	Country or region	Reference
Meat products	< 0.4–2.6	2004	Canada	<a href="#">Tittlemeier et al. (2007)</a>
Meat products ( <i>n</i> = 8)	< 0.071	2006	Catalonia, Spain	<a href="#">Ericson et al. (2008)</a>
Fish, marine	< 0.5	2004	Canada	<a href="#">Tittlemeier et al. (2007)</a>
Fish, freshwater	< 0.5	2004	Canada	<a href="#">Tittlemeier et al. (2007)</a>
Fish, freshwater	< 2	1998	Canada	<a href="#">Tittlemeier et al. (2007)</a>
Trout ( <i>n</i> = 47)	< 2–24	2006	Sauerland, Germany	<a href="#">Wilhelm et al. (2008)</a>
Trout ( <i>n</i> = 39)	< 2–5	2007	Sauerland, Germany	<a href="#">Wilhelm et al. (2008)</a>
Other fish ( <i>n</i> = 33)	< 2–8	2006	Sauerland, Germany	<a href="#">Wilhelm et al. (2008)</a>
Other fish ( <i>n</i> = 73)	< 2	2007	Sauerland, Germany	<a href="#">Wilhelm et al. (2008)</a>
White fish ( <i>n</i> = 2)	< 0.065	2006	Catalonia, Spain	<a href="#">Ericson et al. (2008)</a>
Seafood ( <i>n</i> = 2)	< 0.029	2006	Catalonia, Spain	<a href="#">Ericson et al. (2008)</a>
Fish (muscle tissue)	< 0.2–5	2005	Germany	<a href="#">Gruber et al. (2007)</a>
Fish (liver)	< 0.2–9	2005	Germany	<a href="#">Gruber et al. (2007)</a>
Pizza	0.74	1998	Canada	<a href="#">Tittlemeier et al. (2007)</a>
Microwave popcorn	3.6	1999	Canada	<a href="#">Tittlemeier et al. (2007)</a>
Cereal products ( <i>n</i> = 72)	ND–0.5	1999–2007	Europe and North America	<a href="#">Trudel et al. (2008)</a>
Cereals ( <i>n</i> = 6)	ND	1999–2007	Europe and North America	<a href="#">Trudel et al. (2008)</a>
Cereals ( <i>n</i> = 2)	< 0.080	2006	Catalonia, Spain	<a href="#">Ericson et al. (2008)</a>
Dairy products ( <i>n</i> = 6)	ND	1999–2007	Europe and North America	<a href="#">Trudel et al. (2008)</a>
Dairy products ( <i>n</i> = 2)	< 0.040	2006	Catalonia, Spain	<a href="#">Ericson et al. (2008)</a>
Eggs ( <i>n</i> = 86)	ND	1999–2007	Europe and North America	<a href="#">Trudel et al. (2008)</a>
Eggs ( <i>n</i> = 2)	< 0.055	2006	Catalonia, Spain	<a href="#">Ericson et al. (2008)</a>
Fats and oils ( <i>n</i> = 2)	ND	1999–2007	Europe and North America	<a href="#">Trudel et al. (2008)</a>
Margarine	< 0.115	2006	Catalonia, Spain	<a href="#">Ericson et al. (2008)</a>
Oil	< 0.247	2006	Catalonia, Spain	<a href="#">Ericson et al. (2008)</a>
Fish and shellfish ( <i>n</i> = 155)	ND–2	1999–2007	Europe and North America	<a href="#">Trudel et al. (2008)</a>
Tinned fish	< 0.126	2006	Catalan, Spain	<a href="#">Ericson et al. (2008)</a>
Blue fish	< 0.132	2006	Catalonia, Spain	<a href="#">Ericson et al. (2008)</a>
Fruits ( <i>n</i> = 76)	ND–0.3	1999–2007	Europe and North America	<a href="#">Trudel et al. (2008)</a>
Fruits ( <i>n</i> = 2)	< 0.036	2006	Catalonia, Spain	<a href="#">Ericson et al. (2008)</a>
Meat ( <i>n</i> = 262)	ND–1	1999–2007	Europe and North America	<a href="#">Trudel et al. (2008)</a>
Milk ( <i>n</i> = 82)	ND	1999–2007	Europe and North America	<a href="#">Trudel et al. (2008)</a>
Whole milk ( <i>n</i> = 2)	0.056	2006	Catalonia, Spain	<a href="#">Ericson et al. (2008)</a>
Semi-skimmed milk	< 0.028	2006	Catalonia, Spain	<a href="#">Ericson et al. (2008)</a>
Potatoes ( <i>n</i> = 26)	0.4–2	1999–2007	Europe and North America	<a href="#">Trudel et al. (2008)</a>
Potatoes	< 0.2–3	2006	Germany	<a href="#">Gruber et al. (2007)</a>
Poultry ( <i>n</i> = 78)	ND	1999–2007	Europe and North America	<a href="#">Trudel et al. (2008)</a>
Snacks ( <i>n</i> = 4)	0.9–3	1999–2007	Europe and North America	<a href="#">Trudel et al. (2008)</a>
Sweets ( <i>n</i> = 2)	ND	1999–2007	Europe and North America	<a href="#">Trudel et al. (2008)</a>
Tap water ( <i>n</i> = 102)	0.009–0.02	1999–2007	North America	<a href="#">Trudel et al. (2008)</a>
Tap water ( <i>n</i> = 28)	ND–0.2	1999–2007	Europe	<a href="#">Trudel et al. (2008)</a>



**Table 1.3 (continued)**

Food category	Concentration (ng/g wet weight)	Year of sampling	Country or region	Reference
Vegetables ( <i>n</i> = 77)	ND–0.3	1999–2007	Europe and North America	<a href="#">Trudel et al. (2008)</a>
Vegetables ( <i>n</i> = 2)	< 0.027	2006	Catalonia, Spain	<a href="#">Ericson et al. (2008)</a>
Pulses ( <i>n</i> = 2)	< 0.045	2006	Catalonia, Spain	<a href="#">Ericson et al. (2008)</a>
Water-based drinks ( <i>n</i> = 2)	ND	1999–2007	Europe and North America	<a href="#">Trudel et al. (2008)</a>

ND, not detected

serum concentrations in operators exposed to fluorinated ethylene propylene/perfluoroalkoxy were < 1000 µg/L before 1975, increasing to about 2000 µg/L by 2004. Predicted serum concentrations for operators using the fine powder/granular polytetrafluoroethylene finish declined from about 1500–2000 µg/L in 1950–1980 to about 500–1000 µg/L in 1990–2004. Predicted serum concentrations for job-exposure groups with intermittent direct or plant background exposures were < 1600 µg/L in all years.

Another study of 506 fluoropolymer-production workers in Belgium, Minnesota, and Alabama, USA, reported a median serum concentration of perfluorooctanoate of 1100 µg/L in 2000 ([Olsen & Zobel, 2007](#)). Median serum concentrations of perfluorooctanoate were 650, 950, and 1510 µg/L among workers at the facilities in Belgium, Minnesota, and Alabama, respectively.

In both studies described above, serum perfluorooctanoate measurements exceeded 10 000 µg/L for some workers ([Olsen & Zobel, 2007](#); [Woskie et al., 2012](#)). No measurements of PFOA, ammonium perfluorooctanoate, or precursors in workplace air, work surfaces, or skin were reported in these studies of occupational exposure. In a separate study, [Kaiser et al. \(2010\)](#) reported eight-hour time-weighted average (TWA) concentrations of PFOA in air ranging from 0.004–0.065 mg/m<sup>3</sup> near process sumps in an unidentified facility producing ammonium perfluorooctanoate and PFOA.

In China, 48 workers involved in the manufacture of footwear had mean serum concentrations of PFOA of 6.93 µg/L (range, 0.17–117.7 µg/L) ([Zhang et al., 2011](#)).

As part of an international epidemiological study of workers in six plants manufacturing polytetrafluoroethylene in Germany, the Netherlands, Italy, the United Kingdom, New Jersey, and West Virginia, [Sleuwenhoek & Cherrie \(2012\)](#) estimated exposure to ammonium perfluorooctanoate by inhalation and dermal routes using modelling. The exposure reconstructions were made using descriptive information about the workplace environment and work processes, including changes over time in local ventilation, use of respiratory protective equipment, working in a confined space, outdoor work, cleanliness and the level of involvement of the workers in the process (for example, operator or supervisor). There were very few measurements of exposure available from the plants (all unpublished) and so the exposure estimates were expressed on an arbitrary dimensionless scale. In each plant, the highest estimated exposures to ammonium perfluorooctanoate were considered to have occurred in the polymerization area, with an annual decline in exposure varying from 2.2% to 5.5%. At any point in time, the differences between plants in the average estimated exposure level for polymerization workers were up to about fivefold. Among workers in the six plants whose jobs involved exposure to both tetrafluoroethylene and ammonium perfluorooctanoate, the correlation between the two

exposure estimates was 0.72 ([Sleeuwenhoek & Cherrie, 2012](#)). There were some workers with no exposure to ammonium perfluorooctanoate and low-to-moderate exposure to tetrafluoroethylene, but no workers who were exposed to ammonium perfluorooctanoate without tetrafluoroethylene exposure ([Sleeuwenhoek & Cherrie, 2012](#); [Consonni et al., 2013](#)).

### 1.3.3 Exposure in the general population

#### (a) Serum concentrations

Human exposure to PFOA has often been assessed using measured or predicted concentrations of perfluorooctanoate in serum or plasma ([Eriksen et al., 2009](#); [Fromme et al., 2009](#); [Bonefeld-Jorgensen et al., 2011](#); [Barry et al., 2013](#); [Vieira et al., 2013a](#); [Hardell et al., 2014](#)). The pharmacokinetics of PFOA differ widely between species, with short half-lives and strong sex differences in rats, but a half-life of 2.3–3.5 years and no observed sex differences in humans ([Olsen et al., 2007](#); [Bartell et al., 2010](#)). The Canadian Health Measures Survey reported that the median and geometric mean plasma concentrations of perfluorooctanoate among Canadians aged 20–79 years in 2007–2009 were both 2.5 µg/L, and the 95th percentile was 5.5 µg/L ([Environment Canada, 2012](#)).

The California Environmental Contaminant Biomonitoring Program reported median serum measurements of perfluorooctanoate of 2.49 µg/L for 1337 teachers and school administrators in 2011–2014, and 0.474 µg/L for 77 pregnant women in 2010–2011 ([California Department of Public Health, 2014](#)). [Yeung et al. \(2013\)](#) reported a median serum PFOA concentration of 2.34 µg/L among 25 Australian liver donors in 2007–2009, noting a substantial decline in serum PFOA compared with previous reports of pooled Australian samples in 2002–2003 [7.6 µg/L] ([Kärroman et al., 2006](#)) and 2006–2007 [6.4 µg/L] ([Toms et al., 2009](#)). In a study of 413 pregnant and nursing women in Sweden, serum

PFOA concentrations declined by an average of 3.1% per year (95% CI, 1.8–4.4%) from 1996–2010 ([Glynn et al., 2012](#)).

Geometric mean serum concentrations of perfluorooctanoate in the USA population based on serum measurements from the National Health and Nutrition Examination Survey were 5.2 µg/L, 3.9 µg/L, 3.9 µg/L, and 4.1 µg/L in 1999–2000, 2003–2004, 2005–2006, and 2007–2008, respectively, with similar concentrations in different age groups, but slightly higher concentrations in males than females ([Calafat et al., 2007a](#); [Kato et al., 2011](#)). The 95th percentile of serum perfluorooctanoate concentrations did not exceed 12 µg/L in any of those years ([Kato et al., 2011](#)). Pooled samples from 3802 Australian residents in 2002–2003 yielded a mean perfluorooctanoate serum concentration of 7.6 µg/L ([Kärroman et al., 2006](#)) – a value roughly consistent with the geometric mean in the USA, considering that these measurements were positively skewed. Smaller studies of general populations in Europe, Asia, and the USA for samples collected in 1989–2006 have produced similar findings, with reported average concentrations ranging from 1.6 to 11.6 µg/L ([Fromme et al., 2009](#)).

Several studies of serum measurements of perfluorooctanoate are available for stored samples collected before the 1990s. [Olsen et al. \(2005\)](#) reported a median serum concentration of perfluorooctanoate of 2.3 µg/L for 178 blood samples collected in Maryland, USA, in 1974, and [Harada et al. \(2004\)](#) reported a geometric mean serum concentration of perfluorooctanoate of 0.2 µg/L for 39 blood samples collected from females in Miyagi, Japan, in 1977. [Haug et al. \(2009\)](#) reported serum concentrations of perfluorooctanoate in samples from a biobank of hospital patients in Norway, pooling samples by year ( $n > 19$  for most years) for the period 1977–2006. Perfluorooctanoate serum concentrations in this study rose from 0.58 µg/L in 1977

**Table 1.4 Concentrations of perfluorooctanoic acid (PFOA) in human breast milk**

Food category	Concentration (ng/L)	Year of sampling	Country or region	Reference
Breast milk ( <i>n</i> = 19)	47–210 [100%]	2004	China	<a href="#">So et al. (2006)</a>
Breast milk ( <i>n</i> = 70)	< 200–460 [16%]	2006	Bavaria, Germany	<a href="#">Völkel et al. (2008)</a>
Breast milk ( <i>n</i> = 203)	80–610 [55%]	2007	North Rhine-Westphalia, Germany	<a href="#">Bernsmann &amp; Fürst (2008)</a>
Breast milk ( <i>n</i> = 51)	< LOD–340 [44%]	2007	Japan	<a href="#">Nakata et al. (2007)</a>
Breast milk ( <i>n</i> = 31)	50–300	1999–2007	Europe and North America	<a href="#">Trudel et al. (2008)</a>
Breast milk ( <i>n</i> = 12)	< 209–492	2004	Sweden	<a href="#">Kärroman et al. (2007)</a>

LOD, limit of detection

to 1.3 µg/L in 1980, 3.3 µg/L in 1990, and 4.5 µg/L in 2000, falling to 2.7 µg/L in 2006.

Mean concentrations of perfluorooctanoate were measured in 258 samples of blood, serum, or plasma collected from men between 2000 and 2004 in the USA (Michigan) (5.7 µg/L; < 3–14.7 µg/L), Colombia (6.2 µg/L; 3.9–12.2 µg/L), Brazil (< 20 µg/L), Belgium (5.0 µg/L; 1.1–13 µg/L), Italy (< 3 µg/L), Poland (20.5 µg/L; 11–40 µg/L), India (3.5 µg/L; < 3–3.5 µg/L), Malaysia (< 10 µg/L), suggesting the presence of specific sources of PFOA in this country ([Kannan et al., 2004](#)). Relatively higher concentrations of PFOA were reported in the Republic of Korea (35.5 µg/L; < 15–71.4 µg/L) ([Kannan et al., 2004](#)).

Overall, the published data suggested that serum PFOA concentrations in the general population increased over time until about 2000, and have remained constant or decreased since that time.

Higher serum concentrations of perfluorooctanoate have been reported in general populations near production facilities and other known exposure sources. For example, the geometric mean serum concentration of perfluorooctanoate in 2005–2006 among 69030 residents living near a production facility in West Virginia, USA, was 32.9 µg/L (standard deviation, 241 µg/L). Exposures in that community varied substantially across six water districts; the mean serum concentration of PFOA was about 16 µg/L in the two water districts with the lowest water

concentrations of PFOA, and 228 µg/L in the water district with the highest concentrations ([Frisbee et al., 2009](#)). A study of 641 residents of Arnsberg, Germany, in 2006 reported mean serum concentrations of perfluorooctanoate of 24.6, 26.7, and 28.5 µg/L in children, mothers, and men, respectively, due to surface water contamination from upstream agricultural use of soil conditioner mingled with industrial waste ([Hölzer et al., 2008](#)).

#### (b) Breast milk

PFOA has been measured in breast milk; these data are presented in [Table 1.4](#).

In North Rhine-Westphalia, Germany, more than half of the samples analysed in 2007 (*n* = 203) contained PFOA; concentrations up to 610 ng/L have been reported ([Bernsmann & Fürst, 2008](#)). In China, PFOA was measured in 100% of the breast milk samples analysed (*n* = 19) in 2004 ([So et al., 2006](#)).

#### (c) Exposure sources

As PFOA and its precursors are not routinely or systematically monitored in air, water, dust, food, or drinking-water, the relative contributions of exposure sources in the general population are not well understood. Published studies of exposure have relied on synthesis of environmental measurements collected at varying times and places, often in different countries. These studies comprise the best available data, but are

typically based on convenience samples in one or few locations, and may not be representative of regional, national, or global exposures.

One such study has estimated that diet (including transfer of PFOA from food packaging) contributes 99% of total exposure to PFOA for adults in the general population in “western” countries, with negligible contributions from inhalation and ingestion of house dust and drinking-water (Fromme et al., 2009). Estimated adult mean PFOA intakes via indoor air, outdoor air, house dust, diet, and drinking-water were 0.053, 0.076, 0.986, 169, and 1.3 ng/day, respectively. The estimated dietary contribution was based on PFOA measurements in a 7-day duplicate-diet study of 31 participants aged 16–45 years in Germany (Fromme et al., 2007); estimated inhalation contributions were based on PFOA measurements at one indoor and four outdoor sites in Europe (Barber et al., 2007; the estimated house-dust ingestion contribution was based on measurements of PFOA from 67 homes in Ottawa, Canada, in the winter (Kubwabo et al., 2005), and the estimated contribution of drinking-water ingestion was based on river-water samples from the Rhine and its tributaries in Germany (Skutlarek et al., 2006). The contribution of house dust to PFOA exposure was based on a conservative estimate of 5% conversion of 8:2 FTOH to PFOA. Other precursor concentrations may actually exceed those of PFOA and 8:2 FTOH in house dust, but the extent of precursor metabolism in humans is unclear (De Silva et al., 2012).

Trudel et al. (2008) estimated that ingestion of food and house dust contributed > 90% of exposure to PFOA in adults, noting that PFOA-treated carpets and ingestion of dust may account for a larger proportion of exposure among children than adults. Typical uptake doses of PFOA for infants, toddlers, children, and teenagers/adults were estimated at 9.8, 7.6, 5.0, and 2.5–3.1 ng/kg body weight (bw) per day in North America and 6.0, 7.6, 6.7, and 2.8–4.1 ng/kg bw per day

in Europe, respectively, based primarily on food concentrations of PFOA from data extracted from four previous studies covering 17 food categories with 1–131 samples each (for most food categories, measurements from Europe and North America were combined due to small sample sizes) and house-dust concentrations of PFOA from data from three small studies in Canada, Japan, and the USA (Moriwaki et al., 2003; Costner et al., 2005; Kubwabo et al., 2005). Infants may be exposed primarily through mother’s milk (So et al., 2006; Kärrman et al., 2010; Kim et al., 2011a), for which the estimated perfluorooctanoate concentration was reported as 0.1 ng/g (Trudel et al., 2008).

However, drinking-water may have a larger contribution to exposure to PFOA in some populations. For example, Kim et al. (2011b) estimated that drinking-water ingestion contributes 30% of total exposure to PFOA in the Republic of Korea, where urban water supplies are often contaminated.

Drinking-water is thought to have been the predominant source of intake of PFOA for a highly exposed population near a production facility in West Virginia, USA, studied by the C8 Science Panel (Barry et al., 2013; Vieira et al., 2013a; Steenland et al., 2014), where both surface water and groundwater were contaminated by water and air emissions from the facility (Shin et al., 2011a).

Although residual amounts of PFOA (4–75 ng/g) and 8:2 FTOH are contained in non-stick cookware and can be released to the gas phase in small quantities when heated to normal cooking temperature, their contribution to exposure tends to decline with repeated use and is believed to be negligible compared with other exposure sources (Fromme et al., 2009). One study of four non-stick cookware items (with three samples each) reported emission rates of 19–287 and 42–625 pg/cm<sup>2</sup>, for PFOA and 8:2 FTOH respectively, upon first heating after purchase; concentrations of gas-phase

PFOA were shown to decrease after repeated use (four times) for some cookware brands, but not for others. PFOA may be off-gassed at different rates from non-stick coatings, depending on how the non-stick coating was prepared and applied ([Sinclair et al., 2007](#)).

## 1.4 Regulations and guidelines

The EPA has a Provisional Health Advisory value of 0.4 µg/L for PFOA in drinking-water ([EPA, 2009b](#)).

The European Food Safety Authority (EFSA) recommended a tolerable daily intake (TDI) for PFOA of 1.5 µg/kg bw per day ([EFSA, 2008](#)).

The Environmental Agency of Norway has announced the following limits on PFOA in consumer products, which became effective as from 1 July 2014: 10 ppm in substances and mixtures; 1 mg/m<sup>2</sup> in textiles, carpeting, and other coated consumer products; and 1000 ppm in other consumer products. Food packaging, food contact materials, and medical devices are exempt from these limits in Norway ([UL, 2014](#)).

Germany has established an air quality control limit for PFOA of 0.15 g/hour and 0.05 mg/m<sup>3</sup> of dusts (including ammonium perfluorooctanoate) in exhaust gas ([IFA, 2014](#)).

PFOA and ammonium pentadecafluorooctanoate have been identified by the European Chemicals Agency as a Substance of Very High Concern under Article 57 (c) of the REACH (Registration, Evaluation, Authorisation and Restriction of Chemicals) regulations as toxic for reproduction 1B and under Article 57 (d) as a substance that is persistent, bioaccumulative, and toxic, in accordance with the criteria and provisions set out in Annex XIII of the Regulations ([ECHA, 2013](#)).

## 2. Cancer in Humans

See [Table 2.1](#), [Table 2.2](#) and [Table 2.3](#)

Data on the occurrence of cancer in humans exposed to PFOA are available from epidemiological studies in three different types of populations: workers in chemical plants producing or using PFOA, communities surrounding a plant with environmental release of PFOA and contamination of public and private water supplies, and studies in the general population with background exposures. These studies have focused on cancers of the kidney, bladder, liver, pancreas, testes, prostate, thyroid, and breast because of initial findings from the epidemiological studies, or because of congruence with sites of toxicity identified in experimental studies in animals. Cancer incidence, rather than mortality, provides a stronger basis for inferring causation for these diseases because, except for cancers of the liver and pancreas, survival is relatively high (i.e. 5-year survival, > 70%) for these cancer types ([SEER, 2014](#)). Studies of incident cases of cancer of the prostate may also present challenges with respect to consideration of the influence of use of screening tests (e.g. prostate-specific antigen testing), and variation in use of these tests, among study participants.

### 2.1 Occupational exposure

See [Table 2.1](#)

Studies of occupational cohorts were conducted in plants in West Virginia ([Leonard et al., 2008](#); [Steenland & Woskie, 2012](#)) and Minnesota ([Gilliland & Mandel, 1993](#); [Lundin et al., 2009](#); [Raleigh et al., 2014](#)), USA; results from the most recent general follow-up are summarized in [Table 2.1](#). A study of workers producing tetrafluoroethylene ([Consonni et al., 2013](#)) also provides some potentially relevant information, but was not included in the tables because the study population overlapped with

**Table 2.1 Cohort studies on cancer and occupational exposure to perfluorooctanoic acid (PFOA)**

Reference, location, follow-up period	Total subjects	Exposure assessment	Organ site (ICD code)	Exposure categories	Exposed cases	Relative risk (95% CI)	Covariates and comments	
Steenland & Woskie (2012) West Virginia, USA, 1950–2008	5791	JEM using 2125 serum samples collected in 1979–2004 to develop regression models to predict exposure by year for 8 job-category groups	Kidney	Dupont referent	12	1.28 (0.66–2.24)	SMR, unlagged; no covariates other than those used for rate standardization; two sets of analyses presented (Dupont plants – plants from 8 surrounding states, excluding study plant and US referents); similar patterns seen with 10- and 20-year lags Increased risk of mesothelioma (SMR, 2.85; highest quartile SMR, 6.27)	
				US referent	12	1.09 (0.56–1.90)		
				<i>By quartile (ppm-yr)</i>				
				0 to < 904	1	1.07 (0.02–3.62)		
				904 to < 1520	3	1.37 (0.28–3.99)		
				1520 to < 2720	0	0.0 (0.00–1.42)		
				≥ 2720	8	2.66 (1.15–5.24)		
				Bladder	Dupont referent	10		1.08 (0.52–1.99)
					US referent	10		0.95 (0.46–1.75)
				Liver	Dupont referent	10		1.07 (0.51–1.96)
					US referent	10		0.77 (0.35–1.47)
				Pancreas	Dupont referent	18		1.04 (0.62–1.64)
					US referent	18		0.85 (0.51–1.35)
Breast	Dupont referent	4	0.65 (0.13–1.90)					
	US referent	4	0.79 (0.21–2.02)					
Testis	Dupont referent	1	1.80 (0.05–10.03)					
	US referent	1	0.74 (0.02–4.12)					
Prostate	Dupont referent	21	0.76 (0.47–1.16)					
	US referent	21	0.72 (0.45–1.10)					
All cancers	Dupont referent	304	0.93 (0.83–1.04)					
	US referent	304	0.74 (0.66–0.83)					

Table 2.1 (continued)

Reference, location, follow-up period	Total subjects	Exposure assessment	Organ site (ICD code)	Exposure categories	Exposed cases	Relative risk (95% CI)	Covariates and comments
Raleigh et al. (2014)	4668	JEM using personal and area samples collected in 1977–2000; 8-hour TWA for PFOA calculated for 23 departments and 45 job titles	Kidney [mortality]	Q1–Q2 ( $< 1.5 \times 10^{-4}$ $\mu\text{g}/\text{m}^3\text{-yr}$ ) Q3–Q4 ( $> 1.5 \times 10^{-4}$ $\mu\text{g}/\text{m}^3\text{-yr}$ )	3 3	0.38 (0.11–1.23) 0.39 (0.11–1.32)	Time-dependent Cox regression (HR), by quartile of cumulative exposure, adjusted for year of birth and sex; referent was workers in St Paul, Minnesota (non-exposed; assigned general background exposure)
[update of Lundin et al., 2009 and Gilliland & Mandel, 1993]			Kidney [incidence]	Q1 ( $< 2.9 \times 10^{-5}$ $\mu\text{g}/\text{m}^3\text{-yr}$ ) Q2 ( $2.9 \times 10^{-5}$ to $1.5 \times 10^{-4}$ $\mu\text{g}/\text{m}^3\text{-yr}$ ) Q3 ( $1.5 \times 10^{-4}$ to $7.9 \times 10^{-4}$ $\mu\text{g}/\text{m}^3\text{-yr}$ ) Q4 ( $> 7.9 \times 10^{-4}$ $\mu\text{g}/\text{m}^3\text{-yr}$ )	4 4 4 4	1.07 (0.36–3.16) 1.07 (0.36–3.17) 0.98 (0.33–2.92)	Incidence analysis was limited to 1988–2008
Minnesota, USA, 1947–2008			Bladder [mortality]	Q1–Q2 ( $< 1.5 \times 10^{-4}$ $\mu\text{g}/\text{m}^3\text{-yr}$ ) Q3–Q4 ( $> 1.5 \times 10^{-4}$ $\mu\text{g}/\text{m}^3\text{-yr}$ )	3 5	1.03 (0.27–3.96) 1.96 (0.63–6.15)	Unexposed group from another plant in the area (St Paul, Minnesota) also included ( $n = 4359$ )
			Bladder [incidence]	Q1 ( $< 2.9 \times 10^{-5}$ $\mu\text{g}/\text{m}^3\text{-yr}$ ) Q2 ( $2.9 \times 10^{-5}$ to $1.5 \times 10^{-4}$ $\mu\text{g}/\text{m}^3\text{-yr}$ ) Q3 ( $1.5 \times 10^{-4}$ to $7.9 \times 10^{-4}$ $\mu\text{g}/\text{m}^3\text{-yr}$ ) Q4 ( $> 7.9 \times 10^{-4}$ $\mu\text{g}/\text{m}^3\text{-yr}$ )	7 6 15 12	0.81 (0.36–1.81) 0.78 (0.33–1.85) 1.50 (0.80–2.81) 1.66 (0.86, 3.18)	
			Liver and biliary passages [incidence]	Q1–Q2 ( $< 1.5 \times 10^{-4}$ $\mu\text{g}/\text{m}^3\text{-yr}$ ) Q3–Q4 ( $> 1.5 \times 10^{-4}$ $\mu\text{g}/\text{m}^3\text{-yr}$ )	6 2	2.09 (0.69–6.31) 0.67 (0.14–3.27)	
			Pancreas [mortality] (ICD codes, NR)	Q1 ( $< 2.9 \times 10^{-5}$ $\mu\text{g}/\text{m}^3\text{-yr}$ ) Q2 ( $2.9 \times 10^{-5}$ to $1.5 \times 10^{-4}$ $\mu\text{g}/\text{m}^3\text{-yr}$ ) Q3 ( $1.5 \times 10^{-4}$ to $7.9 \times 10^{-4}$ $\mu\text{g}/\text{m}^3\text{-yr}$ ) Q4 ( $> 7.9 \times 10^{-4}$ $\mu\text{g}/\text{m}^3\text{-yr}$ )	2 5 5 6	0.32 (0.08–1.35) 0.89 (0.34–2.31) 0.82 (0.32–2.12) 1.23 (0.50–3.00)	
			Pancreas [incidence]	Q1–Q2 ( $< 1.5 \times 10^{-4}$ $\mu\text{g}/\text{m}^3\text{-yr}$ ) Q3–Q4 ( $> 1.5 \times 10^{-4}$ $\mu\text{g}/\text{m}^3\text{-yr}$ )	1 9	0.13 (0.02–1.03) 1.36 (0.59–3.11)	

Table 2.1 (continued)

Reference, location, follow-up period	Total subjects	Exposure assessment	Organ site (ICD code)	Exposure categories	Exposed cases	Relative risk (95% CI)	Covariates and comments
Kaleigh et al. (2014) (cont.)	5	Prostate [mortality]	Prostate [mortality]	Q1 (< 2.9 × 10 <sup>-5</sup> µg/m <sup>3</sup> -yr)	5	0.34 (0.25, 1.60)	SMRs calculated based on state (Minnesota) expected rates
				Q2 (2.9 × 10 <sup>-5</sup> to 1.5 × 10 <sup>-4</sup> µg/m <sup>3</sup> -yr)	8	1.12 (0.53–2.37)	
				Q3 (1.5 × 10 <sup>-4</sup> to 7.9 × 10 <sup>-4</sup> µg/m <sup>3</sup> -yr)	3	0.36 (0.11–1.17)	
				Q4 (> 7.9 × 10 <sup>-4</sup> µg/m <sup>3</sup> -yr)	8	1.32 (0.61–2.84)	
	42	Prostate [incidence]	Prostate [incidence]	Q1 (< 2.9 × 10 <sup>-5</sup> µg/m <sup>3</sup> -yr)	42	0.80 (0.57–1.11)	SMRs calculated based on state (Minnesota) expected rates
				Q2 (2.9 × 10 <sup>-5</sup> to 1.5 × 10 <sup>-4</sup> µg/m <sup>3</sup> -yr)	42	0.85 (0.61–1.19)	
				Q3 (1.5 × 10 <sup>-4</sup> to 7.9 × 10 <sup>-4</sup> µg/m <sup>3</sup> -yr)	49	0.89 (0.66–1.21)	
				Q4 (> 7.9 × 10 <sup>-4</sup> µg/m <sup>3</sup> -yr)	55	1.11 (0.82–1.49)	
	8	Breast [mortality]	Breast [mortality]	Q1–Q2 (< 1.5 × 10 <sup>-4</sup> µg/m <sup>3</sup> -yr)	8	0.61 (0.25–1.48)	SMRs calculated based on state (Minnesota) expected rates
				Q3–Q4 (> 1.5 × 10 <sup>-4</sup> µg/m <sup>3</sup> -yr)	3	0.54 (0.15–1.94)	
				Q1 (< 2.9 × 10 <sup>-5</sup> µg/m <sup>3</sup> -yr)	8	0.36 (0.16–0.79)	
				Q2 (2.9 × 10 <sup>-5</sup> to 1.5 × 10 <sup>-4</sup> µg/m <sup>3</sup> -yr)	8	0.65 (0.29–1.42)	
	14	Breast [incidence]	Breast [incidence]	Q1 (< 2.9 × 10 <sup>-5</sup> µg/m <sup>3</sup> -yr)	14	1.47 (0.77–2.80)	SMRs calculated based on state (Minnesota) expected rates
				Q2 (2.9 × 10 <sup>-5</sup> to 1.5 × 10 <sup>-4</sup> µg/m <sup>3</sup> -yr)	4	0.85 (0.29–2.46)	
				Q3 (1.5 × 10 <sup>-4</sup> to 7.9 × 10 <sup>-4</sup> µg/m <sup>3</sup> -yr)	4	0.85 (0.29–2.46)	
				Q4 (> 7.9 × 10 <sup>-4</sup> µg/m <sup>3</sup> -yr)	4	0.87 (0.78–0.97)	
332	All cancers [mortality]	All cancers [mortality]	SMR	332	0.87 (0.78–0.97)	SMRs calculated based on state (Minnesota) expected rates	
			SMR	332	0.87 (0.78–0.97)		

CI, confidence interval; HR, hazard ratio; ICD, International Classification of Disease; JEM, job-exposure matrix; Q, quartile; NR, not reported; SMR, standardized mortality ratio; TWA, time-weighted average; yr, year



other studies, and the assessment of exposure to PFOA was limited. This study is reviewed in detail in the *Monograph* on tetrafluoroethylene, in the present volume. Two other studies examined workers at a plant producing perfluorooctanesulfonyl fluoride in a plant in Alabama, USA ([Alexander et al., 2003](#); [Alexander & Olsen, 2007](#)). The manufacturing process produced PFOA as a by-product, and PFOA was also used in some other production processes and was manufactured at the plant beginning in 1998. The focus of the studies in this plant has been on perfluorooctanesulfonate (PFOS) exposure measures, which are higher than, but correlated with PFOA exposures ([Olsen et al., 2003a](#)); these studies are not discussed further here.

For each of these cohorts, plant operations began around 1950; the study in West Virginia included individuals who had worked at least 1 day ([Steenland & Woskie, 2012](#)), while the Minnesota cohort required at least 365 work days for inclusion ([Raleigh et al., 2014](#)). The proportion of women was approximately 20%, and each was a relatively young cohort. The studies included a cumulative-exposure indicator based on a job-exposure matrix developed using serum PFOA concentrations in workers or air-monitoring data, but differed in terms of the extent of available samples and modelling of exposure, with consideration of changes in exposure over time. Standardized mortality ratios (SMR) for all causes, all cancers, and heart disease ranged from 0.7 to 1.0.

[Steenland & Woskie \(2012\)](#) examined mortality risk in 5791 workers (1084 deaths) in a fluoropolymer-production plant in West Virginia, USA, with a mean follow-up of 30 years. Exposure assessment was based on 2125 blood samples collected from 1979 to 2004. These data were used to define eight job group-categories based on similarity of exposure ([Woskie et al., 2012](#)). The categories included three with direct exposure, four with intermittent direct exposure, and plant background. Restricted cubic spline

regression was used to model serum levels within each job category over time. This analysis was used to develop cumulative exposure estimates for each worker, based on their job-history data. Trends of increasing risk of cancer of the kidney and mesothelioma with increasing exposure to PFOA ( $P = 0.02$ ) were observed, with standardized mortality ratios of 2.66 (95% CI, 1.15–5.24; 8 cases) and 6.27 (95% CI, 2.04–14.63; 5 cases), respectively, in the highest quartile of PFOA exposure. There was no indication of increased risk for cancers of the bladder, liver, pancreas, breast, or prostate ([Table 2.1](#)). [A strength of this study was the detailed exposure analysis, while a limitation was the small numbers. The Working Group interpreted the association between PFOA exposure and risk of mesothelioma to be an indication of exposure to asbestos in these workers.]

[Raleigh et al. \(2014\)](#) examined mortality risk in 4668 workers (1125 deaths) in a plant manufacturing ammonium perfluorooctanoate in Minnesota, USA, with a mean follow-up of 34 years. Exposure assessment was based on 205 personal air samples and 659 area samples collected from production areas in 1977–2000; exposures before 1977 were estimated based on variation in annual production levels; procedures and tasks had not changed over this period. The exposure data were combined with job-history data (department, job title, work area, equipment, task and year) to estimate time-weighted average exposures, which were then used to estimate cumulative exposure estimates for individual workers. Mortality was analysed for the period 1960–2008. Incidence data, based on Minnesota and Wisconsin state cancer registries were also included, but were limited to cases occurring since 1988, when both of these registries were in operation. Workers at another plant in the area, manufacturing tape and abrasive products, were used as the referent group ( $n = 4359$ ) for internal analyses of mortality and incidence. For mortality from cancer of the bladder, the relative risk estimate for the combined upper two

quartiles of exposure (compared with unexposed referents) was 1.96 (95% CI, 0.63–6.15; 5 cases); in the analysis of incidence of cancer of the bladder (40 exposed cases), the pattern across the four quartiles of cumulative exposure was 0.81, 0.78, 1.50, and 1.66, respectively ([Table 2.1](#)). Cancer of the kidney was not associated with exposure to PFOA in analyses of mortality (6 exposed cases) or incidence (16 exposed cases). Examination of incidence and mortality data in relation to cumulative exposure revealed little or no evidence of increased risk of cancer of the liver, pancreas, prostate, or breast. Risks were not analysed for cancers of the thyroid or testes. [The Working Group noted the reasonable quality of the exposure data. Another strength of this study was the use of incidence data, but this analysis covered only a 20-year period, which limited the number of observed cases for some cancers.]

[In summary, these studies conducted in two different occupational cohorts included some evidence of an association between PFOA exposure and cancer of the kidney ([Steenland & Woskie, 2012](#)) or bladder ([Raleigh et al., 2014](#)), with elevated risks seen at higher exposures in one (but not both) of the studies. Elevated risk of cancer of the liver, pancreas, or breast in relation to higher exposure was not seen in either study, and the initial report of an increased risk of cancer of the prostate ([Lundin et al., 2009](#)) was not substantiated in subsequent analyses ([Steenland & Woskie, 2012](#); [Raleigh et al., 2014](#)). These studies did not provide a basis for examining cancer of the testes or thyroid, since an analysis of incidence data was not available for these cancers.]

## 2.2 Community studies of high exposure

See [Table 2.2](#)

An area along the Ohio River in West Virginia and Ohio, USA, surrounding one of the

fluoropolymer production plants described in the previous section has been the site of a series of community health studies. Emissions from this plant resulted in contamination of public water systems and private wells with PFOA. Three studies examined cancer risk for multiple cancer types ([Barry et al., 2013](#); [Vieira et al., 2013b](#)) or specifically for cancer of the colon ([Innes et al., 2014](#)). [The Working Group noted that [Barry et al. \(2013\)](#) and [Vieira et al. \(2013b\)](#) were overlapping, rather than independent studies, in that the same geographical areas and some of the same cases are included in both analyses.]

Using a case-control design, [Vieira et al. \(2013b\)](#) examined incident cancers occurring in 1996–2005, using West Virginia and Ohio state cancer registries. Cases living in 13 counties around the fluoropolymer production plant were identified; analyses were limited to 18 cancer types that were of a-priori interest, or that had at least 100 cases in each state. The controls for each analysis were all other cancer types, excluding cancers of the kidney, liver, pancreas, and testes. In one set of analyses, residence at time of diagnosis was used to assign study participants to specific water districts in Ohio and West Virginia ([Vieira et al., 2010, 2013a](#)). A more robust exposure assessment was used in the second set of case-control analyses, restricted to the Ohio data, where exposure was estimated based on street-level data. This information was combined with emission data, environmental characteristics, and pharmacokinetic data to estimate annual exposure from 1951 to date of diagnosis, assuming that residence at time of diagnosis was the residence for the previous 10 years ([Shin et al., 2011a, b](#)). Residence in a contaminated water district was not associated with a notable increase in the risk of any cancer. In analyses of cancer incidence in relation to estimated serum PFOA concentrations, elevated risks of cancer of the kidney (2.0; 95% CI, 1.0–3.9; 9 cases) and testes (2.8; 95% CI, 0.8–9.2; 6 cases), and more modestly increased risks for cancer of the prostate

**Table 2.2 Community-based studies (high-exposure setting) of cancer and exposure to perfluorooctanoic acid (PFOA)**

Reference, study location, period, design	Total subjects	Exposure assessment	Organ site (ICD code)	Exposure categories	Exposed cases	Relative risk (95% CI)	Covariates and comments
<a href="#">Vieira et al. (2013b)</a> Ohio and West Virginia, USA; case-control study; incident cases and controls from 1996–2005, from state cancer registries	23 107 cancer cases (West Virginia, 17 238; Ohio, 7869)	For Ohio participants (analysis presented here), serum PFOA concentration for 1951–2008 was estimated using geocoded residence, emissions data, environmental characteristics, water pipe installation, and pharmacokinetic data	Kidney [incidence]	<i>Estimated serum levels (µg/L) 10 yr before diagnosis (Ohio)</i> Low: 3.7–12.8 Medium: 12.9–30.7 High: 30.8–109 Very high: > 110	11 17 22 9	0.8 (0.4–1.5) 1.2 (0.7–2.0) 2.0 (1.3–3.2) 2.0 (1.0–3.9)	Logistic regression, adjusted for age, sex, diagnosis year, insurance provider, smoking status, and race; unlagged models also examined, with similar results Controls had cancers other than kidney, liver, pancreas, and testis (numbers not reported) Another set of analyses included both West Virginia and Ohio participants, but was limited to water district-level exposure assessment (not presented here)
			Bladder [incidence]	Low: 3.7–12.8 Medium: 12.9–30.7 High: 30.8–109 Very high: > 110	23	0.9 (0.6–1.4)	
			Liver [incidence]	Low: 3.7–12.8 Medium: 12.9–30.7 High: 30.8–109 Very high: > 110	21 21 4	0.9 (0.6–1.4) 1.2 (0.8–2.0) 0.6 (0.2–1.5)	
			Pancreas [incidence]	Low: 3.7–12.8 Medium: 12.9–30.7 High: 30.8–109 Very high: > 110	4 4 3 0	1.1 (0.4–3.1) 0.9 (0.3–2.5) 1.0 (0.3–3.1) Not estimated	
			Prostate [incidence]	Low: 3.7–12.8 Medium: 12.9–30.7 High: 30.8–109 Very high: > 110	12 10 9 2	1.3 (0.7–2.3) 0.9 (0.5–1.7) 1.1 (0.6–2.3) 0.6 (0.1–2.5)	
			Testis [incidence]	Low: 3.7–12.8 Medium: 12.9–30.7 High: 30.8–109 Very high: > 110	71 65 47 31	1.1 (0.8–1.5) 0.8 (0.6–1.0) 0.8 (0.5–1.1) 1.5 (0.9–2.5)	
			Thyroid [incidence]	Low: 3.7–12.8 Medium: 12.9–30.7 High: 30.8–109 Very high: > 110	1 3 1 6 5 5 3 2	0.2 (0.0–1.6) 0.6 (0.2–2.2) 0.3 (0.0–2.7) 2.8 (0.8–9.2) 0.9 (0.4–2.3) 0.9 (0.4–2.3) 0.7 (0.2–2.1) 0.8 (0.2–3.5)	

**Table 2.2 (continued)**

Reference, study location, period, design	Total subjects	Exposure assessment	Organ site (ICD code)	Exposure categories	Exposed cases	Relative risk (95% CI)	Covariates and comments
<a href="#">Vieira et al. (2013b)</a> (cont.)			Breast, female [incidence]	Low: 3.7–12.8 Medium: 12.9–30.7 High: 30.8–109 Very high: > 110	72 77 45 29	0.9 (0.7–1.2) 1.1 (0.8–1.5) 0.7 (0.5–1.0) 1.4 (0.9–2.3)	
<a href="#">Barry et al. (2013)</a> Ohio and West Virginia, USA Cohort analysis of participants in C8 Health Project (2005–2006); follow-up, 1992–2011	32 541 (28 541 community; 3713 workers)	Modelled estimates of serum PFOA for 1951–2008; for workers, workplace exposure based on JEM and modelling using serum samples and job history data	Kidney [incidence]	Cumulative serum PFOA concentration *Continuous By quartile, 0 lag (mid-point) Q2 (515 ng/mL-yr) Q3 (3085 ng/mL-yr) Q4 (105 770 ng/mL-yr) Trend tests (by quartile medians; by continuous log-transformed)	105 NR NR NR	1.10 (0.98–1.24)  1.23 (0.70–2.17) 1.48 (0.84–2.60) 1.58 (0.88–2.84) P = 0.18; P = 0.10	Proportional hazards modelling, using time-varying cumulative exposure, adjusting for time-varying smoking, time-varying alcohol use, sex, education, 5-yr birth period; results presented are unlagged; 10-yr lag models gave similar results *Continuous analysis based on per unit ln-transformed cumulative serum concentrations

Table 2.2 (continued)

Reference, study location, period, design	Total subjects	Exposure assessment	Organ site (ICD code)	Exposure categories	Exposed cases	Relative risk (95% CI)	Covariates and comments
<a href="#">Barry et al. (2013)</a> (cont.)							
			Bladder [incidence]	*Continuous	105	1.00 (0.89–1.12)	87 of the cases were from the community (non-worker sample): HR = 1.0, 1.34, 1.95, and 2.04 across quartiles (trend <i>P</i> value = 0.20); among the 18 worker cases, HR = 1.0, 0.84, 4.20, 0.83 (trend <i>P</i> value = 0.54)
			Liver [incidence]	*Continuous	9	0.73 (0.43–1.23)	
			Pancreas [incidence]	*Continuous	24	1.00 (0.78–1.29)	
			Prostate [incidence]	*Continuous	446	0.99 (0.93–1.04)	
			Testis [incidence]	*Continuous	17	1.34 (1.00–1.75)	15 of the cases were from the community (non-worker sample): HR = 1.0, 0.80, 3.07 and 5.80 across quartiles (trend <i>P</i> value = 0.05)
				By quartile (mid-point)	NR	1.04 (0.26–4.22)	
				Q2 (513 ng/mL-yr)	NR	1.91 (0.47–7.75)	
				Q3 (2650 ng/mL-yr)	NR	3.17 (0.75–13.45)	
				Q4 (105 302 ng/mL-yr)	NR	<i>P</i> = 0.04; <i>P</i> = 0.05	
				Trend tests (by quartile medians; by continuous log-transformed)			
			Thyroid [incidence]	*Continuous	86	1.10 (0.95–1.26)	78 of the cases were from the community (non-worker sample): HR = 1.0, 1.54, 1.71, and 1.40 across quartiles (trend <i>P</i> value = 0.46); stronger patterns seen among the 8 worker cases; HR = 1.0, 4.64, 9.70, 14.7 (trend <i>P</i> value = 0.04)
				By quartile (mid-point)			
				Q2 (248 ng/mL-yr)		1.54 (0.77–3.12)	
				Q3 (1331 ng/mL-yr)		1.48 (0.74–2.93)	
				Q4 (104 251 ng/mL-yr)		1.73 (0.85–3.54)	
				Trend tests (by quartile medians; by continuous log-transformed)		<i>P</i> = 0.25; <i>P</i> = 0.20	
			Breast [incidence]	*Continuous	559	0.93 (0.88–0.99)	

**Table 2.2 (continued)**

Reference, study location, period, design	Total subjects	Exposure assessment	Organ site (ICD code)	Exposure categories	Exposed cases	Relative risk (95% CI)	Covariates and comments
<a href="#">Innes et al., 2014</a> Ohio and West Virginia, USA Case-control study among participants in C8 Health Project (see <a href="#">Barry et al., 2013</a> )	208 prevalent cases (self-report with verification by chart review) and 47 151 controls (no reported history of cancer)	Serum PFOA, collected in 2005–2006	Colorectum	<i>By quartile</i> 13.5–27.8 ng/mL 27.9–71.2 ng/mL ≥ 71.3 ng/mL Trend tests (by quartiles; by continuous log-transformed)	36 49 65	0.47 (0.31–0.74) 0.49 (0.33–0.74) 0.61 (0.42–0.89) <i>P</i> = 0.001; <i>P</i> = 0.35	Age, race, sex, education, income, employment status/disability, marital status, smoking status, current alcohol consumption, vegetarian diet, exercise programme, BMI, menopausal status, self-report of 12 conditions, and current treatment for hypertension or hyperlipidaemia. Similar patterns seen in analyses stratified by sex or BMI, and in analyses limited to diagnosis within 6 yr with no change in residence since 1990 ( <i>n</i> = 71 cases) or since 1990 ( <i>n</i> = 60 cases)

BMI, body mass index; CI, confidence interval; HR, hazard ratio; ICD, International Classification of Disease; NR, not reported; yr, year

(1.5; 95% CI, 0.9–2.5; 31 cases), and breast (1.4; 95% CI, 0.9–2.3; 29 cases) were observed in the upper 10% of the exposure distribution. There was no indication of an increased risk of cancers of the bladder, liver, pancreas, or thyroid ([Table 2.2](#)). [A strength of this study was its use of incidence data. A limitation was that for the part of the sample residing in West Virginia, it was not possible to conduct the more detailed exposure assessment based on street addresses, reducing the sample size for these analyses. Another limitation was that the residential data were limited to only one residence (i.e. residence at time of diagnosis), rather than a more complete residential history.]

[Barry et al. \(2013\)](#) examined incident cancers occurring in 1992–2011 based on self-reported cancer diagnoses from questionnaires administered in 2005–2006 and 2008–2011 in a cohort identified as a result of a lawsuit brought by residents of the area surrounding the fluoropolymer production plant in West Virginia (the C8 Health Project cohort; [Frisbee et al., 2009](#)). Cancer diagnoses were verified through the state cancer registries or medical record review ([Barry et al., 2013](#)). The total sample size was 32 254, of whom 3713 (11.5%) had worked at some time in the production plant. Individual-level data on residential history, drinking-water source, and tap-water consumption were obtained from the questionnaires. Annual exposure from 1952 to date of diagnosis was estimated using models incorporating this questionnaire data, emission data, environmental characteristics, and pharmacokinetic ([Shin et al., 2011a, b](#)). For workers, workplace exposure based on serum samples and job-history data was also estimated. [Barry et al. \(2013\)](#) included exposure–response analyses based on cumulative exposure measures for cancers of the kidney, testes, and thyroid. In analyses with no exposure lag, the relative risks for cancer of the kidney ( $n = 105$  cases) were 1.23, 1.48, and 1.58 in quartiles 2, 3, and 4, respectively, compared with the lowest quartile

of exposure ( $P$  for trend, based on continuous variable measure, 0.10). For cancer of the testes ( $n = 17$  cases), relative risks of 1.04, 1.91, and 3.17 across quartiles of exposure were observed ( $P$  for trend, 0.05). The trend  $P$  using another test (i.e. using median values of quartiles) was 0.04, and the two  $P$  values for trend in the 10-year lagged analysis were 0.02 and 0.10, respectively, for quartile and continuous analysis. For cancer of the thyroid, the relative risks by quartile were 1.54, 1.48, and 1.73 ( $P$  for trend, 0.20). Similar results were obtained with a 10-year exposure lag. There was no indication of increased risk for the other cancer sites (liver, pancreas, prostate, and breast) ([Table 2.2](#)). [The strengths of this study included its use of incidence data and individual-level exposure modelling using lifetime residential history, and the validation of the exposure modelling.]

[Innes et al. \(2014\)](#) conducted a case–control study of prevalent cases of cancer of the colorectum among 47 359 participants in the C8 Health Project (see [Barry et al., 2013](#)), using medical history and blood samples collected in the 2005–2006 survey. Self-reported cases of cancer of the colorectum, verified by chart review ( $n = 208$ ) were compared to the 47 151 participants who did not report a history of any type of cancer. An inverse association was seen between serum PFOA concentrations and risk of cancer of the colorectum, including in analyses restricted to cases diagnosed within the past 6 years who had lived in the same residence for the previous 10 or 15 years ([Table 2.2](#)). [A limitation of this study was that the PFOA measurements were taken after diagnosis, and so may not have reflected the etiologically relevant exposure to PFOA.]

## 2.3 Studies in the general population

See [Table 2.3](#)

Three population-based case-control studies were available that examined PFOA serum concentrations in relation to various types of cancer ([Eriksen et al., 2009](#); [Bonefeld-Jorgensen et al., 2011](#); [Hardell et al., 2014](#)). Exposure levels in these studies were considerably lower than those seen in the community studies of high exposure or occupational studies described previously.

[Eriksen et al. \(2009\)](#) was a nested case-control study of cancers of the bladder ( $n = 332$  cases), liver ( $n = 67$  cases), pancreas ( $n = 128$  cases), and prostate ( $n = 713$  cases) among 57 053 people in Denmark aged 50–65 years at baseline; 772 controls selected from the cohort were frequency-matched to the sex distribution of the cases. Blood samples were taken at enrolment and stored for later analysis, with a median time between enrolment and diagnosis of 7 years. Median PFOA concentration among controls was 6.6 ng/mL. There was no association between variation in PFOA exposure in this population and risk of cancers of the bladder or liver ([Table 2.3](#)). For cancer of the pancreas, the rate ratio in the highest quartile was 1.55 (95% CI, 0.85–2.80), and for cancer of the prostate the corresponding rate ratio was 1.18 (95% CI, 0.84–1.65). PFOS was also measured in the blood samples; the correlation between PFOA and PFOS was  $r = 0.70$ . PFOS was not associated with cancers of the bladder, liver, or pancreas. For cancer of the prostate, however, the rate ratio for the highest quartile of PFOS exposure was 1.38 (95% CI, 0.99–1.93) [A strength of this study was that the PFOA measurements were based on samples collected before diagnosis, and thus are likely to reflect an etiologically relevant time-window of exposure; however, the number of cases of cancer of the liver was relatively small. Another limitation was the relatively high correlation between PFOA and PFOS, which hampered

interpretation of the association with cancer of the prostate seen with each of these exposures.]

[Hardell et al. \(2014\)](#) examined risk of cancer of the prostate in relation to serum concentrations of PFOA in a case-control study in Sweden in 2007–2011 ( $n = 201$  cases, 186 controls). PFOA concentration was measured in whole blood samples collected after enrolment (i.e. after diagnosis for cases); among controls, the median PFOA concentration was 1.9 ng/mL (range, 0.35–8.4 ng/mL). There was no association between PFOA concentration and cancer of the prostate in the analysis of the full sample, but a relative risk of 2.6 (95% CI, 1.2–6.0) was seen among individuals who reported a first-degree relative with cancer of the prostate, and who had a serum PFOA concentration that was above the median for controls (compared with individuals with no family history of cancer of the prostate and serum PFOA concentration that was greater than the median for controls) ([Table 2.3](#)). [A limitation of this study was that the PFOA measurements were taken after diagnosis, and so may not reflect a relevant time-window of exposure.]

[Bonefeld-Jorgensen et al. \(2011\)](#) examined risk of cancer of the breast in relation to PFOA exposure (and other environmental exposures, including polychlorinated biphenyls, organochlorine pesticides, and metals) in a small case-control study (31 cases and 115 controls) of incident cases of cancer of the breast in Greenland in 2002–2003. Serum PFOA concentrations were measured in samples taken at the time of diagnosis for cases, and at enrolment for controls; among controls, the median PFOA concentration was 1.6 ng/L (95% CI, 2.11–2.90). Only 7 cases and 69 controls were included in analyses adjusting for covariates (age, body mass index, pregnancy, cotinine, breastfeeding, and menopausal status) because of missing data ([Table 2.3](#)). [The Working Group considered this study to be uninformative because of the small sample size resulting from the high proportion of missing covariate data.]



**Table 2.3 Case-control studies of cancer of the bladder, liver, prostate, pancreas, or breast and exposure to perfluorooctanoic acid (PFOA)**

Reference, study location, period	Total cases Total controls	Control source (hospital, population)	Exposure assessment	Organ site (ICD code)	Exposure categories	Exposed cases	Relative risk (95% CI)	Covariates and comments
<a href="#">Erikssen et al. (2009)</a> Denmark Nested case-control study; initial cohort enrolled 1993-1997 and followed until 2006	1240 cases (332 bladder; 713 prostate; 67 liver; 128 pancreas) 772 controls	Cohort	Plasma sample taken at baseline	Bladder	<i>By quartile</i> 2 3 4 <i>per 1 ng/mL increase</i>	82 83 83 332	0.71 (0.46-1.07) 0.92 (0.61-1.39) 0.81 (0.53-1.24) 1.00 (0.95-1.05)	Smoking status, intensity, and duration, years of school, 9 occupations
				Prostate	<i>By quartile</i> 2 3 4 <i>per 1 ng/mL increase</i>	178 178 178 713	1.09 (0.78-1.53) 0.94 (0.67-1.32) 1.18 (0.84-1.65) 1.03 (0.99-1.07)	Years of school, BMI, dietary fat intake, fruit and vegetable intake
				Liver	<i>By quartile</i> 2 3 4 <i>per 1 ng/mL increase</i>	17 17 16 67	1.00 (0.44-2.23) 0.49 (0.22-1.09) 0.60 (0.26-1.37) 0.95 (0.86-1.06)	Smoking status, years of school, alcohol intake, occupation
				Pancreas	<i>By quartile</i> 2 3 4 <i>per 1 ng/mL increase</i>	32 32 32 128	0.88 (0.49-1.57) 1.33 (0.74-2.38) 1.55 (0.85-2.80) 1.03 (0.98-1.10)	Smoking status, intensity, and duration, dietary fat intake, fruit and vegetable intake

**Table 2.3 (continued)**

Reference, study location, period	Total cases	Control source (hospital, population)	Exposure assessment	Organ site (ICD code)	Exposure categories	Exposed cases	Relative risk (95% CI)	Covariates and comments
<a href="#">Hardell et al. (2014)</a> Sweden, 2007–2011	201 cases 186 controls	Population registry: matched on age and geographical area	Blood sample (collected at time of diagnosis)	Prostate	Above vs below median in controls (1.9 ng/mL) Effect modification by family history (first-degree relative with prostate cancer): Family history negative, PFOA ≤ median Family history positive, PFOA ≤ median Family history positive, PFOA > median Family history negative, PFOA > median Family history positive, PFOA > median	108 77 16 84 24	1.1 (0.7–1.7) 1.0 (referent) 1.1 (0.5–2.6) 1.0 (0.6–1.5) 2.6 (1.2–6.0)	Age, BMI, year of blood sampling
<a href="#">Bonfeld-Jørgensen et al. (2011)</a> Greenland, 2000–2003	31 cases 115 controls	Population: frequency matched by age and district from two studies on persistent organochlorines	Blood sample, collected at diagnosis for cases and enrolment for controls	Breast	Median in controls: 1.6 ng/mL	7	1.20 (0.77–1.88) per unit increase in ln-transformed serum PFOA	Age, BMI, pregnancies, and cotinine; because of missing data, only 7 cases and 69 controls were included in the adjusted analysis

BMI, body mass index; CI, confidence interval; ICD, International Classification of Disease; vs, versus; yr, year

### 3. Cancer in Experimental Animals

PFOA was tested for carcinogenicity by the oral route of exposure (in the feed) in two studies in rats. There were also four initiation–promotion studies: two studies in rats and two studies in rainbow trout. No studies of carcinogenicity in mice exposed to PFOA were available to the Working Group.

#### 3.1 Rat

See [Table 3.1](#)

##### 3.1.1 Oral administration

Two 2-year studies of carcinogenicity had been conducted with PFOA (specifically, ammonium perfluorooctanoate, or C8) in Sprague-Dawley rats.

The first study was conducted by a pharmaceutical company in the USA. Original reports of this study were submitted as regulatory documents to the EPA in 1983, and were not publicly available until [Butenhoff et al. \(2012a\)](#) published a report of this study. In this study, male and female Sprague-Dawley rats [CrI:COBS@CD(SD)BR] (age, 39–41 days) were given diets containing PFOA at a concentration of 0, 30, or 300 ppm, corresponding to an average daily dose of approximately 0, 1.3, and 14.2 mg/kg bw in males, and 0, 1.6, and 16.1 mg/kg bw in females. At 2 years, there was a significant treatment-related increase in the incidence of testicular Leydig cell adenoma in males at 300 ppm compared with concurrent controls, but not at 30 ppm. There was an increase in the incidence of fibroadenoma of the mammary gland in females at 30 and 300 ppm, but only the increase in the group at 300 ppm was significant compared with concurrent controls. There was an increase in the incidence of hepatocellular hypertrophy in males and females at the highest dose, and an increase in the incidence of liver cystic degeneration and

portal mononuclear cell infiltrate in males at the highest dose ([Butenhoff et al., 2012a](#)). In 2005, a pathology working group was convened to review the original slides of the mammary glands and to provide a consensus diagnosis for the neoplasms of the mammary gland using current diagnostic criteria. The pathology working group concluded that several lesions originally diagnosed as lobular hyperplasia had features consistent with fibroadenoma of the mammary gland (mainly in slides from the control group), and that, consequently, PFOA did not induce neoplasms of the mammary gland ([Hardisty et al., 2010](#)). In a review of the pancreatic lesions from the male rats, using the same diagnostic criteria as those applied in the study by [Biegel et al. \(2001\)](#) (see below), a significant increase in the incidence of pancreatic acinar cell hyperplasia was identified at the highest dose (3/46, 1/46, 10/47) ([Caverly-Rae et al., 2014](#)). These hyperplastic lesions were considered to be proliferative lesions similar to the pancreatic acinar adenomas seen in the study by [Biegel et al. \(2001\)](#), and this supported the conclusion that the pancreas is a target of PFOA in male rats.

In the second study, designed to compare the carcinogenic effects of Wyeth-14643 with those of PFOA (specifically, ammonium perfluorooctanoate) ([Biegel et al., 2001](#)), there was a treatment group in which male Sprague-Dawley rats [CrI:CD BR (CD)] (age, 6 weeks) were given diet containing PFOA at a concentration of 300 ppm for 2 years. There was also a control group that was fed ad libitum, and a control group that received the same amount of food as the PFOA-treated group (pair-fed control group). The average daily doses of PFOA were 0, 0, and 13.6 mg/kg bw in the control group fed ad libitum, the pair-fed control group, and the treated group, respectively. There were initially 156 animals per group, but rats were killed at various interim time-points for measurements of cell proliferation, peroxisome proliferation, and hormone levels. [It was unclear how many rats were designated for pathological

**Table 3.1 Studies of carcinogenicity with perfluorooctanoic acid (PFOA) in rats**

Reference Species, strain (sex) Duration	Dosing regimen Animals/group at start	Results For each target organ: incidence (%) and/or multiplicity of tumours	Significance	Comments
<a href="#">Butenhoff et al. (2012a)</a> , <a href="#">Hardisty et al. (2010)</a> Rat, Sprague-Dawley Cri: COBS CD(SD)BR (M) 24 mo	Diet containing 0, 30, 300 ppm [actual doses: 0, 1.3, and 14.2 mg/kg bw per day 65 control and high-dose groups, 50 low-dose group (15 rats from control and high-dose groups were killed at 1 year)	Leydig cell adenoma: 0/49, 2/50 (4%), 7/50 (14%)*	*P < 0.05	Ammonium perfluorooctanoate (purity, > 97.2%) No neoplasms at 1-year interim kill Survival: 35/50 (70%), 36/50 (72%), 44/50 (88%)
<a href="#">Butenhoff et al. (2012a)</a> , <a href="#">Hardisty et al. (2010)</a> Rat, Sprague-Dawley Cri: COBS CD(SD)BR (F) 24 mo	0, 1.6, and 16.1 mg/kg bw per day	Mammary gland, fibroadenoma: 10/46 (22%), 19/45 (42%), 21/44 (48%)*	*P < 0.05	Survival: 25/50 (50%), 24/50 (48%), 29/50 (58%) No neoplasms at 1-year interim kill Peer review of the mammary gland data by a panel of pathologists ( <a href="#">Hardisty et al., 2010</a> ) using contemporary diagnostic criteria generated the following incidence data (with no statistical significance): Mammary gland fibroadenoma: 16/50 (32%), 16/50 (32%), 20/50 (40%) Mammary gland fibroadenoma, multiple: 2/50 (4%), 6/50 (12%), 3/50 (6%)
<a href="#">Biegel et al. (2001)</a> Rat, Sprague-Dawley Cri: CD BR (CD) (M) 24 mo	Diet containing PFOA at 0 (controls fed ad libitum), 0 (pair-fed controls), or 300 ppm [actual doses: 0, 0, 13.6 mg/kg bw per day] 156 rats/group	Hepatocellular adenoma: 2/80 (3%), 1/79 (1%), 10/76 (13%)* Hepatocellular carcinoma: 0/80, 2/79 (3%), 0/76 Hepatocellular adenoma or carcinoma (combined): 2/80 (3%), 3/79 (4%), 10/76 (13%)* Leydig cell adenoma: 0/80, 2/78 (3%), 8/76 (11%)* Pancreatic acinar cell adenoma: 0/80, 1/79 (1%), 7/76 (9%)* Pancreatic acinar cell carcinoma: 0/80, 0/79, 1/76 (1%) Pancreatic acinar cell adenoma or carcinoma (combined): 0/80, 1/79 (1%), 8/76 (11%)*	*P < 0.05	Ammonium perfluorooctanoate (purity, 98–100%) Survival: ~15%, ~33%, ~47% [estimated from a graph] Only the liver, testes, epididymides, pancreas, and organs with gross lesions were examined microscopically Leydig cell hyperplasia: 11/80 (14%), 26/78 (33%), 35/76 (46%)* Pancreatic acinar cell hyperplasia: 14/80 (18%), 8/79 (10%), 30/76 (39%)* Some rats were designated for interim kill for measurement of cell proliferation, hormone, and peroxisome proliferation, and unclear how many were designated for pathological evaluation at the 2 year time-point

Table 3.1 (continued)

Reference Species, strain (sex) Duration	Dosing regimen Animals/group at start	Results For each target organ: incidence (%) and/or multiplicity of tumours	Significance	Comments
<a href="#">Abdellatif et al. (1991)</a> Rat, Wistar (ICO;WI IOPS AF/Han) (M) 12 mo	Initiation–promotion study NDEA given by single i.p. injection, PFOA and PB (positive control) in diet Initiation: 200 mg/kg bw NDEA (all 4 groups) Promotion: 0% (control), 0.05% PB, 0.015% PFOA, or 0.02% PFOA 10 rats/group	Hepatocellular carcinoma: 0/7, 2/7 (28%), 1/7 (16%), 5/9 (55%)*	* $P < 0.05$	Analytical-grade PFOA (purity, NR) Average daily dose of PFOA, NR Only the liver was collected for microscopic evaluation Survival: 7/10 (70%), 7/10 (70%), 7/10 (70%), 9/10 (90%) (no tumours found in rats that died early)
<a href="#">Abdellatif et al. (1990, 1991)</a> Rat, Wistar (ICO;WI IOPS AF/Han) (M) 28 wk	Initiation–selection–promotion study NDEA given by single i.p. injection, 2-AAF administered in diet, CCl <sub>4</sub> given by gavage, PFOA and PB administered in diet Initiation: 200 mg/kg bw NDEA (all 3 groups) Selection: 2 wk after initiation, 0.03% 2-AAF for 2 wk; after 1 wk of 2-AAF treatment, rats received one dose of CCl <sub>4</sub> at 2 mL/kg bw in corn oil Promotion: 0% (control), 0.05% PB or 0.15% PFOA Control group: 7 rats; PB: 8 rats; PFOA-treated: 12 rats	Hepatic cancers (all): 0/7, 6/8 (75%)*, 4/12 (33%)**	* $P < 0.02$ ** $P < 0.05$	Analytical-grade PFOA (purity, NR) Average daily dose of PFOA, NR Only the liver was collected for microscopic evaluation Hepatic cancers in phenobarbital- treated group were hepatocellular carcinomas. Three hepatic cancers in the PFOA-treated group were hepatocellular carcinomas and one was reported as “other” but was not further classified

2-AAF, 2-acetylaminofluorene; bw, body weight; CCl<sub>4</sub>, carbon tetrachloride; F, female; i.p., intraperitoneal; M, male; mo, month; NDEA, N-nitrosodiethylamine; NR, not reported; PB, phenobarbital; wk, weeks; yr, year

evaluation at the 2-year time-point. Survival data were provided in graphic form only (the actual numbers were not reported); the Working Group estimated survival percentages from the graph presented.] At 2 years, exposure to PFOA significantly increased the incidence of hepatocellular adenoma, testicular Leydig cell adenoma, pancreatic acinar cell adenoma, and pancreatic acinar cell adenoma or carcinoma (combined). In the testis, there was also an increase in the incidence of Leydig cell hyperplasia in the treated group compared with concurrent controls ([Biegel et al., 2001](#)).

### 3.1.2 Initiation–promotion

In an initiation–promotion study, male Wistar rats were given *N*-nitrosodiethylamine (NDEA) at a dose of 200 mg/kg bw as a single intraperitoneal injection (initiation), followed 2 weeks later by diet containing 0.05% phenobarbital, 0.015% PFOA [analytical grade, purity not reported], or 0.02% PFOA, for 46 weeks ([Abdellatif et al., 1991](#)). A control group was initiated with NDEA and was fed untreated diet. There were 10 rats per group. The average daily doses of phenobarbital and PFOA were not reported. Survival in the initiated group was 7/10, 7/10, 7/10, and 9/10 in the control group, the phenobarbital-treated group, and the groups treated with 0.015% PFOA, and 0.02% PFOA, respectively. No tumours were identified in rats that died at an early stage of the experiment, all within the first 8 months of the study, with the cause of death reported to be pneumonia in all cases. At 12 months, there was a significant increase in the incidence of NDEA-induced hepatocellular carcinoma in the rats receiving 0.02% PFOA compared with the control group. No organs other than the liver were evaluated in this study. [The Working Group noted the small number of animals and the absence of liver tumours in the control group.]

In an initiation–selection–promotion study, male Wistar rats were initiated with NDEA at a dose of 200 mg/kg bw as a single intraperitoneal injection ([Abdellatif et al., 1990, 1991](#)). After 2 weeks, they were given diet containing 0.03% 2-acetylaminofluorene (2-AAF) for 2 weeks. After 1 week of treatment with 2-AAF, the rats received a single necrogenic dose of carbon tetrachloride (2 mL/kg bw) by gavage. One week after the cessation of treatment with 2-AAF, the rats were given diet containing 0.05% phenobarbital or 0.015% PFOA for 23 weeks. A control group were initiated with NDEA then received 2-AAF plus carbon tetrachloride, but was fed untreated diet. The average daily doses of 2-AAF, phenobarbital, or PFOA were not reported. There were 7 rats in the control group, 8 rats in the phenobarbital-treated group, and 12 rats in the PFOA-treated group. Survival was 100% in all groups. The incidences of hepatic cancers were 0/7, 6/8, and 4/12 in the control, phenobarbital-treated, and PFOA-treated groups, respectively. The incidences in the phenobarbital-treated and PFOA-treated groups were significantly increased compared with controls. The cancers reported were hepatocellular carcinomas in all cases, except for one in the PFOA-treated group, that was reported as “other histologic type” and not further classified. [The Working Group noted the small number of animals, the absence of liver tumours in the control group, and the large amount of 2-AAF and chloroform administered.]

## 3.2 Rainbow trout

See [Table 3.2](#)

### Initiation–promotion

Rainbow trout have been used as a model of hepatic carcinogenesis for many years and are sensitive to several suspected human carcinogens, including the hepatic carcinogens aflatoxin B<sub>1</sub> (AFB<sub>1</sub>) and polycyclic aromatic hydrocarbons

**Table 3.2 Studies of carcinogenicity with perfluorooctanoic acid (PFOA) in the rainbow trout**

Reference Species, strain (sex) Duration	Route Dosing regimen Animals/group at start	Incidence of tumours	Significance	Comments
<a href="#">Benninghoff et al. (2012)</a> Rainbow trout, Mount Shasta strain (M, F) 10 mo	Initiation–promotion study Treatment groups were as follows: – 0.01% EtOH (non-initiated sham control)/untreated diet; – 0.01% EtOH /promotion with 2000 ppm PFOA for 6 mo; – initiation with 10 ppb AFB <sub>1</sub> for 30 min/untreated diet; – initiation with 10 ppb AFB <sub>1</sub> for 30 min/promotion with 2000 ppm PFOA for 6 mo ~250 fish/group	Hepatic neoplasms (all): 0%, 0%, 13%, 62%*	* $P < 0.01$ (vs AFB <sub>1</sub> /untreated feed group)	Analytical-grade PFOA (purity, NR) Untreated diet: OTD (semipurified, casein-based) Incidence values, NR (only percentages) Distribution of hepatic neoplasms for AFB <sub>1</sub> /control group: 26% hepatocellular adenomas, 23% hepatocellular carcinomas, 2% mixed adenomas, 47% mixed carcinomas, 2% cholangiocellular carcinomas Distribution of hepatic neoplasms for AFB <sub>1</sub> /PFOA group: 10% hepatocellular adenomas, 27% hepatocellular carcinomas, 1% mixed adenomas, 54% mixed carcinomas, 4% cholangiocellular adenomas, 5% cholangiocellular carcinomas Hepatic neoplasms were classified according to <a href="#">Hendricks et al. (1984)</a>
<a href="#">Benninghoff et al. (2012)</a> Rainbow trout, Mount Shasta strain (M, F) 10 mo	Initiation–promotion study Treatment groups were as follows: – 0.01% DMSO (non-initiated sham control)/untreated diet; – initiation with 35 ppm MNNG for 30 min/untreated diet; – initiation with 35 ppm MNNG for 30 min/promotion with 2000 ppm PFOA for 6 mo ~167 fish/group	Hepatic neoplasms (all): 0%, 51%, 86%*	$P < 0.001$ (vs MNNG/untreated diet group)	Analytical-grade PFOA (purity, NR) Untreated diet: OTD (semipurified, casein-based) Incidence values, NR (only percentages) Distribution of hepatic neoplasms for MNNG/control group: 25% hepatocellular adenomas, 28% hepatocellular carcinomas, 3% mixed adenomas, 39% mixed carcinomas, 2% cholangiocellular adenomas, 3% cholangiocellular carcinomas Distribution of hepatic neoplasms for MNNG/PFOA group: 26% hepatocellular adenomas, 11% hepatocellular carcinomas, 4% mixed adenomas, 55% mixed carcinomas, 3% cholangiocellular adenomas, 1% cholangiocellular carcinomas Hepatic neoplasms were classified according to <a href="#">Hendricks et al. (1984)</a>

AFB<sub>1</sub>, aflatoxin B<sub>1</sub>; DMSO, dimethyl sulfoxide; EtOH, ethanol; F, female; M, male; min, minute; MNNG, *N*-methyl-*N'*-nitro-*N*-nitrosoguanidine; mo, month; OTD, Oregon test diet; NR, not reported; vs, versus

([Williams et al., 2003](#), [Williams, 2012](#)). The background incidence of hepatic neoplasms is reported to be approximately 0.1% at age 9–12 months ([Williams et al., 2003](#)).

In an initiation–promotion study in rainbow trout (Mount Shasta strain), one cohort of four groups (with approximately 250 fish per group) was exposed to either 0.01% ethanol (non-initiated sham control) or 10 ppb AFB<sub>1</sub> for 30 minutes by aqueous exposure at 10 weeks post-spawn. Another cohort of three groups (with approximately 167 trout per group) was exposed to either 0.01% dimethylsulfoxide (non-initiated sham control) or *N*-methyl-*N'*-nitro-*N*-nitrosoguanidine (MNNG) at 35 ppm for 30 minutes by aqueous exposure at 10 weeks post-spawn. For the subsequent 4 weeks, the trout were fed untreated feed (Oregon Test Diet, or OTD, a semipurified, casein-based diet). Beginning at 14 weeks post-spawn (4 weeks after initiation), the trout were given feed containing PFOA at 2000 ppm for six months after which the trout were held for 3 months before necropsy. Control trout were fed untreated OTD. The average daily dose of PFOA was not reported.

In the first cohort, there were four groups: non-initiated sham control/untreated feed control, AFB<sub>1</sub>/untreated feed control, non-initiated sham control/PFOA, and AFB<sub>1</sub>/PFOA. Neither non-initiated group developed hepatic neoplasms. The group initiated with AFB<sub>1</sub> had an incidence of hepatic neoplasms of 13%, while the group initiated with AFB<sub>1</sub> and promoted with PFOA had an incidence of hepatic neoplasms of 62%, which was significant compared with the AFB<sub>1</sub>/control group. In the second cohort, there were three treatment groups as follows: non-initiated sham control/untreated feed control, MNNG/untreated feed control, and MNNG/PFOA. While the control/control group did not develop hepatic neoplasms, both MNNG-initiated groups developed hepatic neoplasms. There was, however, a significant increase in the incidence of hepatic neoplasms in the MNNG/

PFOA group (86%) compared with the MNNG/control group (51%) ([Benninghoff et al., 2012](#)).

## 4. Mechanistic and Other Relevant Data

### 4.1 Toxicokinetic data

An extensive database was available on the toxicokinetics of PFOA in humans, non-human primates, rodents and other species of experimental animal. Toxicokinetic studies have been conducted in adult animals, and also in pregnant or lactating dams, neonates and fetuses at various stages of development. In addition, several physiologically based pharmacokinetic models have been developed for humans and animals (primates and rodents), and for different life stages.

#### 4.1.1 Absorption

PFOA is essentially completely absorbed after oral exposure, and is also absorbed dermally and by inhalation of dust.

##### (a) Humans

The only experimental data in humans were from a phase I clinical trial that used a purified straight-chain isomer of the ammonium salt of PFOA (compound CXR1002, United States patent application publication 2013/0029928) ([Elcombe et al., 2013](#)). A total of 43 subjects (all with tumours of varying tissue origin) were given an oral dose of 50–1200 mg of CXR1002 each week, for up to 6 weeks. Rapid absorption was observed and peak plasma concentrations were noted at ~1.5 hours. After repeated weekly doses, plasma levels increased in stepped increments in all subjects, indicating continued absorption and accumulation with repeated exposure. The study group comprised an approximately equal number of males and females, ranging in age



from age 39 to 78 years; no age or sex differences in the internal dose were found.

Percutaneous absorption of the ammonium salt of PFOA through human skin was shown in an in-vitro study, which reported the permeability coefficient to be  $9.49 \pm 2.86 \times 10^{-7}$  cm/h (Fasano et al., 2005).

(b) *Experimental systems*

(i) *Non-human primates*

The pharmacokinetics of PFOA have been investigated in one set of experiments in non-human primates. Specifically, groups of four to six male cynomolgus monkeys were given daily (7 days per week) oral doses (0, 3, 10 or 20 mg/kg bw) of the ammonium salt of PFOA for 6 months, and pharmacokinetic data were collected (Butenhoff et al., 2002, 2004). While blood samples were collected only at approximately 2-week intervals, and considerable variability occurred, serum levels of PFOA reached steady state within 4–6 weeks after initiation of treatment. Mean serum PFOA values per group during treatment increased with, but were not linearly proportional to, dose. Incomplete absorption was suggested by lower observed steady-state serum PFOA concentrations from oral exposures than predicted from a single intravenous exposure (Butenhoff et al., 2004).

(ii) *Rats*

Oral bioavailability of the ammonium salt of PFOA in rats (males and females) is approximately 100% (Kennedy et al., 2004). For example, after a single oral dose of <sup>14</sup>C-labelled PFOA ammonium salt in male CD rats, 93% of the administered dose was absorbed within 24 hours (Gibson & Johnson, 1979). After PFOA administration by oral (up to 25 mg/kg bw) or intravenous (1 mg/kg bw) routes in male and female Sprague-Dawley rats, similar concentration–time profiles were observed in plasma, indicating 100% oral bioavailability (Kemper & Jepson, 2003). This study also reported that peak

plasma concentrations were observed at 1.25 and 10.5 hours for females and males, respectively, after oral administration. However, it is likely that these different concentrations were due to sex differences in excretion (discussed below), rather than differences in absorption. A study by Cui et al. (2010) demonstrated that more than 92% of the dose was absorbed when male Sprague-Dawley rats were exposed to PFOA (0, 5, and 20 mg/kg bw per day once daily by gavage for 28 days).

In a study of inhalation exposure of PFOA (0, 1, 8, or 84 mg/m<sup>3</sup>, 6 hours per day, 5 days per week for 2 weeks) in Crl:CD rats, absorption was found to be dose-dependent (Kennedy et al., 1986). Similar to the results from oral and intravenous exposures, peak blood levels of PFOA were observed at less than 1 hour and 8 hours for females and males, respectively (Kennedy et al., 2004). PFOA absorption after inhalation exposures to aerosols (0, 1, 10, or 25 mg/m<sup>3</sup>) was studied in male and female Sprague-Dawley rats (Hinderliter, 2003). Effective absorption was shown in both sexes; however, the male C<sub>max</sub> values were approximately 2–3 times higher than the female C<sub>max</sub>. [The Working Group noted that this could be due to sex differences in elimination.]

As demonstrated by detection of PFOA in blood, the ammonium salt of PFOA (0, 20, 200, or 2000 mg/kg bw, 6 hours per day, 5 days per week for 2 weeks) in male Crl:CD rats was effectively absorbed after dermal administration; however, the rate of absorption was not estimated (Kennedy, 1985). Percutaneous absorption of ammonium salt of PFOA through rat skin was shown in an in-vitro study that reported the permeability coefficient to be  $3.25 \pm 1.51 \times 10^{-5}$  cm/h (Fasano et al., 2005).

(iii) *Mice*

Rapid absorption of PFOA, as judged by the time of maximum observed concentration (4–8 hours), was observed in male and female

CD1 mice given single oral doses of PFOA at 1 and 10 mg/kg (Lou et al., 2009). The concentrations of PFOA in the liver and kidney followed a kinetic profile similar to that in blood. PFOA concentrations in the liver were found to be higher than those in sera, while both were substantially higher than in the kidney.

#### (iv) *Other species*

Indirect evidence of dermal absorption was provided by the demonstration of PFOA lethality in a study of male and female New Zealand White rabbits exposed dermally to PFOA at a dose of 100, 1000, or 2000 mg/kg bw per day for 14 days (O'Malley & Ebbins, 1981). No quantitative data were obtained on serum or tissue concentrations of PFOA; all animals died in the group at the highest dose, some died in the group at the intermediate dose, and none died in the group at the lowest dose.

### 4.1.2 *Distribution*

#### (a) *Humans*

The high solubility of PFOA in water suggests wide distribution in the body. Systemic availability of PFOA is expected, as it has been measured in human blood after environmental, occupational, and experimental clinical exposures (Calafat et al., 2007b; Olsen et al., 2007; Bartell et al., 2010; Elcombe et al., 2013). Some, but not all, human donor livers also contained quantifiable levels of PFOS, presumably due to environmental exposures (Olsen et al., 2003b). In a recent study of perfluorinated chemicals in five autopsy tissues from 20 individuals in Spain (Pérez et al., 2013), the largest amounts of PFOA (per g wet weight of tissue) were found in bone, followed by the lung, liver, and kidney. PFOA was not detected in the brain. PFOA was found in the kidney, albeit in smaller amounts, in 95% of subjects, while detectable levels in liver, bone and lung were observed in 42–55% of subjects. The median ratio of PFOA concentrations in

cerebrospinal fluid versus blood was reported as  $17.6 (\times 10^{-3})$ , suggesting that PFOA cannot pass freely through the blood–brain barrier (Harada et al., 2007). Yeung et al. (2013) reported detectable levels of PFOA in all matched samples of serum (range, 0.44–45.5 ng/mL) and liver (range, 0.10–2.3 µg/mL) from 66 subjects who underwent liver transplantation.

PFOA has been found in human breast milk (Kärman et al., 2007; Tao et al., 2008; Völkel et al., 2008; von Ehrenstein et al., 2009; Llorca et al., 2010; Thomsen et al., 2010) and in umbilical cord blood (Apelberg et al., 2007a, b; Midasch et al., 2007; Monroy et al., 2008; Chen et al., 2012; Arbuckle et al., 2013), indicating that it can cross the placenta and partition into milk, exposing the fetus and neonate.

Multiple studies have demonstrated that PFOA can bind substantially to plasma proteins, potentially limiting distribution to tissues. In a study of human plasma protein fractions, albumin,  $\beta$ -lipoproteins, and  $\alpha$ -globulin bound effectively to PFOA, with albumin being most efficient (> 96% binding); other human plasma proteins exhibited binding of < 10% (Kerstner-Wood et al., 2003). Analysis of PFOA distribution into serum lipoprotein fractions in humans found that 40% of the administered dose of PFOA can bind to  $\beta$ -lipoproteins in physiological saline. In human donor plasma lipoprotein fractions, however, most PFOA was found in lipoprotein-depleted plasma. Plasma density gradient fractionation suggested that only 1% or less of PFOA is distributed to lipoprotein-containing fractions (Butenhoff et al., 2012b). Overall, it has been estimated that more than 90% of PFOA would be bound to serum albumin in human blood (Han et al., 2003). Consistent with this estimate, another study with various concentrations of PFOA (1–500 ppm) observed > 99% protein binding in human plasma (Kerstner-Wood et al., 2003).

PFOA also has affinity for liver fatty acid-binding protein (L-FABP), but far less than that

of a natural ligand oleic acid ([Luebker et al., 2002](#)). [Weiss et al. \(2009\)](#) used a radioligand-binding assay to measure binding of PFOA and other perfluorinated compounds to serum human thyroid hormone transport protein, transthyretin; PFOA was found to have a high binding affinity for transthyretin and caused inhibition of binding of the natural ligand, thyroxine (T4).

(b) *Experimental systems*

(i) *Non-human primates*

Systemic availability of PFOA has also been demonstrated in non-human primates. A single intravenous dose of PFOA potassium salt of 10 mg/kg bw was administered to three male and three female cynomolgus monkeys that were aged approximately 3–4 years at the start of the study ([Butenhoff et al., 2004](#)). The monkeys were observed, and urine, faeces, and blood were collected for up to 123 days after the injection. The volume of distribution at steady-state was  $181 \pm 12$  and  $198 \pm 69$  mL/kg for males and females, respectively, which suggests distribution primarily in extracellular space ([Butenhoff et al., 2004](#)).

Data on tissue distribution in non-human primates were limited to the liver. In a study in male cynomolgus monkeys given the ammonium salt of PFOA by oral gavage (for up to 6 months), PFOA concentrations in the liver were less than those in either serum or urine, and did not increase in linear proportion to dose ([Butenhoff et al., 2002, 2004](#)). [The Working Group noted that the steady-state serum PFOA concentrations were lower than would have been predicted from the study of intravenous administration ([Butenhoff et al., 2004](#)) and suggested the existence of enterohepatic recirculation of PFOA.]

Plasma protein binding has also been observed in non-human primates. Greater than 99% protein binding was observed in monkey

plasma at various concentrations of PFOA (1–500 ppm) ([Kerstner-Wood et al., 2003](#)).

(ii) *Rats*

Several studies on the tissue distribution of PFOA in rats suggested that most of the delivered dose is found in the blood, liver, and kidney ([Johnson et al., 1984](#); [Ylinen et al., 1990](#); [Kemper & Jepson, 2003](#); [Kennedy et al., 2004](#)). In male rats given  $^{14}\text{C}$ -labelled PFOA ammonium salt as a single gavage dose at 10 mg/kg bw, small amounts (5–10% of the administered dose) were found in the lungs, heart and skin, and trace amounts (0.5–3%) were found in the testes, muscle, fat, and brain 5 days after dosing ([Kennedy et al., 2004](#)). Female CD rats given  $^{14}\text{C}$ -labelled PFOA ammonium salt as a single oral dose at 10 mg/kg bw had negligible amounts of the radioactive compound in organs and tissues collected 5 days after dosing ([Hundley et al., 2006](#)). The volume of distribution values in male and female rats were similar to those found in cynomolgus monkeys ([Ohmori et al., 2003](#); [Butenhoff et al., 2004](#)).

In plasma from male and female rats, most PFOA (> 90%) was found to be in protein-bound form, and the primary PFOA-binding protein in rat plasma was serum albumin ([Ylinen et al., 1990](#); [Han et al., 2003](#); [Ohmori et al., 2003](#)). At various concentrations of PFOA (1–500 ppm), > 97% protein binding was observed with rat plasma ([Kerstner-Wood et al., 2003](#)). There was little evidence that PFOA binds to glutathione or other thiols such as coenzyme A ([Kuslikis et al., 1992](#); [Vanden Heuvel et al., 1992a](#)).

PFOA is known to enter enterohepatic circulation in the rat, but this process is not a major elimination route ([Johnson et al., 1984](#)).

Transplacental transfer of PFOA was reported to occur in the rat. In a study in 19-day pregnant dams given  $^{14}\text{C}$ -labelled PFOA as a single oral gavage dose at 10 mg/kg bw, PFOA was detected in fetuses with maternal blood:fetal ratio of

22:4.5 between 2 and 8 hours, respectively, after dosing ([Kennedy et al., 2004](#)).

The placental and lactational transport pharmacokinetics of PFOA in rats were studied by [Hinderliter et al. \(2005\)](#). In this study, time-mated female rats were given PFOA by oral gavage once daily at concentrations of 3, 10, or 30 mg/kg bw per day, starting on day 4 of gestation and continuing until termination. Steady-state concentrations of PFOA in breast milk were found to be 10 times less than those in maternal plasma. The concentration of PFOA in fetal plasma on day 21 of gestation was approximately half the steady-state concentration in maternal plasma. The concentrations in milk appeared to be generally similar to the concentrations in pup plasma. PFOA was also detected in placenta (days 15 and 21 of gestation), amniotic fluid (days 15 and 21 of gestation), embryo (days 10 and 15 of gestation), and fetus (day 21 of gestation).

#### (iii) Mice

The available data on distribution in mice were consistent with studies in humans, non-human primates, and rats. In male and female CD-1 mice given  $^{14}\text{C}$ -labelled PFOA ammonium salt as single and repeated doses at 10 mg/kg bw, the largest amounts of radiolabelled compound were found in the blood and liver ([Kennedy et al., 2004](#)). Trace amounts (0.2–3% of the administered dose) were found in other tissues, including the kidneys, skin, lungs, heart, testes, muscle, fat, and brain. No sex difference in tissue distribution was observed.

Several studies in mice addressed exposure to PFOA in utero and in breast milk. In a single-dose study, maternal and pup fluids and tissues were collected over time after exposure to different doses of PFOA (0, 0.1, 1, or 5 mg/kg bw) administered on day 17 of gestation ([Fenton et al., 2009](#)). Serum PFOA concentrations were significantly higher in pups than their respective dams, and their body burden of PFOA increased after birth until at least postnatal day 8, regardless

of dose, indicating exposure through milk. The distribution of PFOA in milk compared with serum was found to be in excess of 0.20. In a repeat-dosing study with PFOA administered on days 1–17 or 10–17 of gestation, high PFOA concentrations were found in the liver and serum of the offspring for up to 6 weeks after birth; brain concentrations were low, and became undetectable 4 weeks after birth ([Macon et al., 2011](#)). Although maternal exposures in this study ceased on day 17 of gestation, the body burden of PFOA in the pups continued to increase until day 14 after birth, which was indicative of breast milk-derived PFOA exposure in the newborns.

#### (iv) Other species

In male and female rabbits (New Zealand White) and male hamsters (BIO-15.16) given a single oral gavage dose of  $^{14}\text{C}$ -labelled PFOA ammonium salt at 10 mg/kg bw, organs and tissues contained negligible amounts of radiolabel by 168 or 120 hours, respectively, after dosing ([Hundley et al., 2006](#)). Female hamsters in the same study had the highest concentrations of radiolabel (7–9%) in the blood, liver, and kidneys, followed by the lungs, heart, and skin (all 3–4%). Negligible amounts (< 2%) were found in the fat, muscle, and brain ([Kennedy et al., 2004](#); [Hundley et al., 2006](#)).

### 4.1.3 Metabolism

Evidence from studies in humans and experimental animals (i.e. rats) shows that PFOA is not metabolized. [D'eon & Mabury \(2011\)](#) failed to detect any biotransformation products of PFOA in the faeces of rats exposed to polyfluoroalkyl phosphate esters. Moreover, no conjugation of PFOA to lipids or polar metabolites of PFOA in the urine or bile of male or female rats was detected ([Vanden Heuvel et al., 1991](#)). Despite PFOA being an organic acid and belonging to a diverse group of peroxisome proliferators that have been hypothesized to require activation by

**Table 4.1 Species- and sex-specific differences in the elimination half-life of perfluorooctanoic acid (PFOA)**

Species	Sex	Elimination half-life	Reference
Human	Mostly males	3.8 yr	<a href="#">Olsen et al. (2007)</a>
	Males and females	2.3 yr	<a href="#">Bartell et al. (2010)</a>
Monkey, cynomolgus	Male	21 ± 12.5 days (i.v.) 19.5–20.8 days (p.o.)	<a href="#">Noker (2003)</a> , <a href="#">Butenhoff et al. (2004)</a>
	Female	32.5 ± 8.0 days (i.v.)	
Rat	Male	7–12 days	<a href="#">Kemper &amp; Jepson (2003)</a>
	Female	< 1 day	
Mouse	Male	19–21 days	<a href="#">Kudo &amp; Kawashima (2003)</a> , <a href="#">Lou et al. (2009)</a>
	Female	15–17 days	
Dog	Male	20–23 days	<a href="#">Hanhijärvi et al. (1988)</a>
	Female	8–13 days	
Rabbit	Males and females	< 1 day	<a href="#">Kudo &amp; Kawashima (2003)</a>
Cattle	Male	< 1 day	<a href="#">Lupton et al. (2012)</a>

i.v., intravenous; p.o., oral; yr, year

formation of a coenzyme A (CoA) thioester, no CoA derivative has been found ([Kuslikis et al., 1992](#)). Based on PFOA having a free carboxyl group, another potential metabolic pathway is glucuronidation. However, in-vitro studies in liver microsome preparations from rat and human liver, kidney, and intestines also failed to detect formation of PFOA–glucuronide ([Kemper & Nabb, 2005](#)). Fluorine-19 nuclear magnetic resonance (NMR) spectroscopy of various body fluids and livers of male Fischer 344 rats exposed to PFOA detected only the parent compound, and showed no evidence for any fluorine-containing metabolites ([Goecke et al., 1992](#)). The absence of metabolism seems to be accounted for by the extremely strong fluorocarbon bonds in the PFOA molecule ([Ophaug & Singer, 1980](#); [Vanden Heuvel et al., 1991](#)).

#### 4.1.4 Excretion

PFOA is eliminated primarily in the urine, with lesser amounts eliminated in the faeces (including as a result of biliary excretion) and expired air. Available data on elimination half-lives of PFOA by species and sex are summarized in [Table 4.1](#). Renal clearance is the major

determinant of the elimination rate, and is inversely correlated ( $r^2 = 0.91$ ) with serum half-life across species ([Han et al., 2012](#)). Sex-specific differences in the elimination of PFOA have also been observed in some, but not all, species. For instance, male hamsters excrete PFOA more rapidly than female hamsters. In dogs, the half-life of PFOA is longer in males. In cynomolgus monkeys, the half-life of PFOA is somewhat longer in females. In contrast, sex-specific differences are not observed in mice or rabbits, or in humans. Renal transport processes have also been hypothesized to be determinants of overall renal clearance. The available data for different species are described below.

##### (a) Human

Two studies in humans were informative with regard to providing numerical estimates of the serum half-life of PFOA. In a study of 26 (24 male, 2 female) retired fluorochemical-production workers (at the time of initial blood collection, subjects had been retired for an average of 2.6 years), followed up for 5 years, the arithmetic mean serum half-life of PFOA was 3.8 years ([Olsen et al., 2007](#)). In a study of 200 people

(equal male/female participation) exposed via public water supplies and followed for 1 year after installation of filtration for the water supplies, the mean half-life was 2.3 years (Bartell et al., 2010). A clinical trial with CXR1002, a purified straight-chain isomer of the ammonium salt of PFOA, could not determine the elimination half-life due to the relatively short duration of the study (less than 6 weeks), other than to determine that it was greater than 6 weeks (Elcombe et al., 2013).

Biliary excretion of PFOA was significantly higher than serum clearance via the urine, but does not substantially contribute to overall elimination, due to high biliary reabsorption (Harada et al., 2007).

Of all species studied, humans have the highest estimated percentage of renal tubular reabsorption of PFOA – 99.94% – an observation that has been attributed to the high affinity of PFOA for human uptake transport proteins (Han et al., 2012). Two transporters on the basolateral membrane of human proximal tubular cells have been identified as contributing to renal secretion (i.e. uptake from blood into the cell) of PFOA, namely the organic anion transporter 1 (OAT1; solute carrier family 22 member 6 *SLC22A6*) and organic anion transporter 3 (OAT3; *SLC22A8*) (Nakagawa et al., 2008). This has been established by the use of human embryonic kidney HEK 293 cells expressing the specific transporter cDNAs. Both transporters are secondary active carriers that mediate the uptake of a broad range of organic anions in an electroneutral exchange for 2-oxoglutarate. Both carriers exhibited a reasonably high affinity for PFOA, with  $K_m$  values for OAT1 and OAT3 being 48  $\mu\text{M}$  and 49.1  $\mu\text{M}$ , respectively (Nakagawa et al., 2008). Human organic anion transporter 2 (OAT2; *SLC22A7*) does not participate in PFOA uptake across the basolateral membrane (Han et al., 2012). No transporters in human renal proximal tubular cells have been identified as being responsible for the efflux step, which involves transport of PFOA

from the renal cell across the apical brush-border membrane (BBM) and into the tubular lumen.

Besides secretion, PFOA that undergoes glomerular filtration can also be reabsorbed by transport from the tubular lumen across the BBM and into the proximal tubular cell. Two human renal BBM carriers, the organic anion transporter 4 (OAT4; *SLC22A11*) and urate transporter 1 (URAT1; *SLC22A12*) have been identified as mediating the initial step in the reabsorption of PFOA (Nakagawa et al., 2009; Yang et al., 2010). OAT4, which is only expressed in human kidney, is thought to act primarily in the facilitated uptake of organic anions, and URAT1 similarly mediates the facilitated uptake of various organic anions including urate. While OAT4 exhibited a lower affinity for PFOA (172–310  $\mu\text{M}$ ) than the basolateral membrane carriers, the affinity of URAT1 for PFOA (64.1  $\mu\text{M}$ ) was similar to that of OAT1 and OAT3 (Yang et al., 2010). In addition to the various *SLC22A* family proteins on the BBM, human kidney also expresses carriers from the solute carrier organic anion (SLCO) family of organic anion-transporting polypeptides (OATPs). The major SLCO carrier in the BBM of human proximal tubular cells is OATP1A2 (*SLCO1A2*). Despite its broad specificity for catalysing uptake of organic anions and even some organic cations, OATP1A2 is not capable of transporting PFOA (Yang et al., 2010; Han et al., 2012).

Like the process of secretion, which ends with efflux across the BBM (i.e. cell to lumen), reabsorption ends with efflux across the basolateral membrane (i.e. cell to blood). Also similar to the process of secretion for PFOA, no specific carrier involved in the efflux step at the basolateral membrane has been identified in human proximal tubules. Thus while efflux clearly occurs and is carrier-mediated, no evidence is available for a role for any of the major efflux carriers (e.g. multidrug resistance-associated proteins) in PFOA transport.

(b) *Experimental systems*

(i) *Non-human primates*

In cynomolgus monkeys (three males and three females) given a single intravenous dose of PFOA potassium salt at 10 mg/kg bw, the range of serum PFOA elimination half-lives was 14–42 days, with a mean of  $21 \pm 12.5$  days in males and  $32.5 \pm 8$  days in females. The difference in elimination between the sexes was not statistically significant (Noker, 2003).

In male cynomolgus monkeys treated with repeated oral doses of the ammonium salt of PFOA, the serum PFOA elimination half-life was 19.5 days and 20.8 days for groups that received PFOA at 10 mg/kg bw or 20 mg/kg bw, respectively (Butenhoff et al., 2002, 2004). First-order elimination kinetics were reported for both doses. Elimination through the urine and faeces (via bile and enterohepatic recirculation) was reported with a much greater (at least three-fold) concentration of PFOA in the urine than in faeces at all doses tested, indicating that the amount of PFOA eliminated in the faeces was at least 25-fold lower than in the urine (per mg of PFOA excreted calculated using estimated faecal and urine quantities).

It was estimated that in Japanese macaque, the process of reabsorption of PFOA predominates over clearance, with 81% and 91% reabsorption in females and males, respectively (Han et al., 2012). However, it is not clear which renal transporters may be responsible for clearance and reabsorption of PFOA in non-human primates.

(ii) *Rats*

In a study in rats given  $^{14}\text{C}$ -labelled PFOA intravenously, females excreted essentially 100% of the administered dose within the first 24 hours after dosing. In contrast, the males excreted only about 20% of the administered dose within 24 hours; by 36 days after dosing, male rats had excreted 83% via the urine and 5.4% via the faeces, and retained 2.8% and 1.1% of the total

radiolabel administered in the liver and plasma, respectively, with detectable levels in other tissues (Johnson & Ober, 1980). Similar observations were made after oral administration. For example, in a study of CD rats given a single oral dose (10 mg/kg bw) of  $^{14}\text{C}$ -labelled PFOA ammonium salt, substantial sex differences in excretion were observed (Hundley et al., 2006). Female rats excreted > 99% of the radiolabel within 120 hours after dosing, while the male rat excreted only 39% in the same time period.

In studies of oral and intravenous administration of PFOA, approximately 25% of the radiolabel in females and 10% in males was found in the faeces, representing either unabsorbed PFOA (in oral studies) or PFOA from biliary excretion. For example, in male Charles River CD rats, a single intravenous dose of  $^{14}\text{C}$ -labelled PFOA ammonium salt (13.3 mg/kg bw) was eliminated in the urine and faeces, although elimination in the urine was about twofold higher than in the faeces after a 14-day observation period (Johnson et al., 1984).

Biliary excretion and faecal elimination of PFOA was reported to be a minor pathway in male and female rats (Kudo et al., 2001). Biliary excretion is slower in male than female rats (Kudo et al., 2001).

In a study that compared the rate of urinary excretion of PFOA (2 mg/kg bw, by oral gavage) in male and female Holtzman rats, female rats were found to excrete 76% of the administered dose in 24 hours, while male rats excreted only 9% (Hanhijärvi et al., 1982). This suggested that, in female rats, PFOA may be eliminated by an active secretion mechanism, because of the high PFOA:inulin clearance ratio, and the fact that PFOA clearance was inhibited by probenecid, an inhibitor of active renal secretion system, by over sevenfold in female rats; in males, the inhibition was less than twofold.

Sex-specific differences in the renal clearance of PFOA in the rat have been attributed to sex-hormone dependence. Testosterone was

shown to inhibit renal excretion of PFOA in male rats, but not females ([Vanden Heuvel et al., 1992b](#)). Conversely, estradiol increased urinary excretion of PFOA in castrated and intact male rats ([Ylinen et al., 1989](#)). Sex-specific differences in serum concentration, but not renal clearance, of PFOA were also reported in weanling rats, suggesting that the difference in renal clearance in adult rats may be a result of sexual maturation ([Kojo et al., 1986](#)). Indeed, the sex-specific difference in PFOA elimination is developmentally regulated and the ability of female rats to rapidly excrete PFOA develops at between age 3 and 5 weeks ([Hinderliter et al., 2006](#)).

It has been hypothesized that a saturable renal transport process (reabsorption) in the proximal tubule of the kidney is responsible for the long plasma half-lives of PFOA in male rats. In female rats, net secretion of PFOA predominates over net reabsorption, while in male rats the opposite is true, with the estimated percentage of reabsorption at 94% ([Han et al., 2012](#)). No evidence is available for the function of a specific rat basolateral membrane efflux carrier in PFOA reabsorption.

Transporter activity has been studied in rats, and several organic anion transporters have been found to mediate PFOA transport, including Oat1, Oat3, Urat1, and Oatp1a1 ([Yang et al., 2009a](#); [Weaver et al., 2010](#)).  $K_m$  values that are similar to those of the human orthologues, in the range of 50–80  $\mu\text{M}$ , have been reported for rat Oat1 and Oat3 ([Nakagawa et al., 2008](#); [Weaver et al., 2010](#)). In models of heterologous expression, rat Oat3 exhibited a 1.5-fold higher  $V_{\text{max}}$  for PFOA than rat Oat1, suggesting that the former may play the larger role in PFOA uptake from the blood and in renal secretion ([Weaver et al., 2010](#)).

The transporters on the BBM of the proximal tubular cells that are involved in PFOA transport are very different in rats and humans. While OAT4 (only expressed in humans) and URAT1 are the carriers identified from the BBM of human proximal tubules, only the rat organic

anion transporting polypeptide 1a1 (Oatp1a1; *Slco1a1*) has been confirmed to transport PFOA from the tubular lumen into the proximal tubular cell ([Yang et al., 2009a](#)). Neither Urat1 and Oat2 function in PFOA uptake across the rat renal BBM. Regarding efflux across the BBM, which is the critical last step in the renal secretion process, no specific carriers have been identified, but Mrp2 does not function in PFOA efflux ([Han et al., 2012](#)).

The sex-specific difference in rat elimination half-life for PFOA has been suggested to be due to differential expression of renal transporter proteins, in particular Oatp1a1 ([Kudo et al., 2002](#); [Weaver et al., 2010](#)). It is not clear, however, whether sex differences in expression of other transporters may play a role in clearance of PFOA, as no differences between males and females were observed in studies with PFOA and probenecid, an inhibitor of both Oat1 and Oat3 ([Kudo et al., 2002](#)).

### (iii) Mice

In a study of male and female CD-1 mice treated with  $^{14}\text{C}$ -labelled PFOA ammonium salt as a single oral dose (10 mg/kg bw), both male and female mice excreted only 21% of the administered radiolabel by 120 hours after dosing ([Hundley et al., 2006](#)). The estimates of percentage of PFOA renal reabsorption in mice are > 95% in both males and females ([Han et al., 2012](#)). No information on the role of specific basolateral membrane carriers from mouse proximal tubule in PFOA uptake or efflux was available.

### (iv) Other species

In a study of male and female hamsters and rabbits treated with a single oral dose of  $^{14}\text{C}$ -labelled PFOA ammonium salt (10 mg/kg bw), the male hamster excreted > 99% of the radiolabel by 120 hours after dosing; conversely, the female hamster excreted only 60% of the radiolabel by 120 hours after dosing ([Hundley et al., 2006](#)). The male and female rabbits excreted



the radiolabel rapidly and completely within 168 hours after dosing. Indeed, renal tubular secretion of PFOA predominates over reabsorption (Han et al., 2012).

In a study of male and female Beagle dogs given PFOA (30 mg/kg bw) intravenously, no sex-specific differences in renal clearance were found, although some difference in the plasma half-life of PFOA was observed (Hanhijärvi et al., 1988). In male dogs, plasma half-life was about 21 days, while in female dogs it was approximately 11 days. Administration of probenecid had a significant effect in both sexes, indicating that elimination of PFOA occurs through an active renal secretion mechanism.

In a study of Angus cattle, <sup>14</sup>C-labelled PFOA administered as a single oral dose (1 mg/kg bw) was completely excreted in the urine within 9 days of dosing (Lupton et al., 2012).

## 4.2 Genotoxicity and related effects

No data on in-vivo genotoxicity in humans exposed to PFOA were available to the Working Group.

Table 4.2 summarizes the studies available investigating the genotoxic potential of PFOA in human cell lines in vitro, in mammalian systems in vitro and in vivo, in non-mammalian eukaryotic system in vitro, and in bacterial and other systems.

### 4.2.1 Human cell lines

In vitro, PFOA increased the levels of 8-hydroxydeoxyguanosine (8-OH-dG) and of reactive oxygen species (ROS) in cultured human hepatoma HepG2 cells in the absence of metabolic activation, and induced DNA strand breaks, as assessed by the comet assay (Yao & Zhong, 2005). [The Working Group noted that the genotoxic effects observed in HepG2 cells were probably due to oxidative DNA damage induced by intracellular ROS.]

In a study by Eriksen et al. (2010) in human HepG2 cells, PFOA did not induce strand breaks or formamidopyrimidine-DNA glycosylase-sensitive sites in the comet assay. Florentin et al. (2011) confirmed that PFOA induced neither DNA damage in the comet assay nor micronucleus formation in the micronucleus assay in human HepG2 cells. The study also showed a decrease in ROS generation.

PFOA did not cause chromosomal aberrations in human lymphocytes with or without metabolic activation (Murli, 1996a; NOTOX, 2000). Induction of micronuclei in human HepG2 cells was observed in the absence of metabolic activation (Yao & Zhong, 2005). In human-hamster hybrid (AL) cells (containing a standard set of CHO-K1 chromosomes and a single copy of human chromosome 11), PFOA (16 days at 200 μM) induced mutagenic effects (Zhao et al., 2011). No significant increase in the frequency of mutation was observed after shorter treatments of 1, 4, or 8 days. Intracellular ROS, superoxide anions (O<sub>2</sub><sup>•-</sup>), and nitric oxide (NO) levels were increased after 1 day of treatment with PFOA at 100 μM (41.5 μg/mL) (no further increase was observed at > 100 μM or with longer exposure time). On the other hand, no mutagenic effects and no increase in ROS or O<sub>2</sub><sup>•-</sup> generation was observed in mitochondrial-DNA deficient human-hamster hybrid (p°AL) cells treated with PFOA for up to 16 days. ROS inhibitor decreased the PFOA-induced mutagenic effect observed in AL cells. Caspase activities in AL cells were increased by PFOA exposure, and suppressed by inhibitors of ROS or nitrogen species.

### 4.2.2 Other experimental systems

#### (a) Mammalian systems

##### (i) Gene mutation

Sadhu (2002) showed that PFOA did not induce gene mutation in hypoxanthine-guanine phosphoribosyl transferase *Hprt* locus when

**Table 4.2 Studies of genotoxicity of perfluorooctanoic acid (PFOA) in human and mammalian cell lines in vitro, in mammalian systems in vivo, in non-mammalian eukaryotic systems in vitro, and in bacterial and other systems**

Test system	Results <sup>a</sup>		Dose <sup>b</sup> (LED or HID)	Reference
	Without exogenous metabolic system	With exogenous metabolic system		
<b>Humans in vitro</b>				
8-hydroxydeoxyguanosine, human hepatoma HepG2 cells	+	NT	41.5	<a href="#">Yao &amp; Zhong (2005)</a>
DNA strand breaks (comet assay), human hepatoma HepG2 cells	+	NT	21	<a href="#">Yao &amp; Zhong (2005)</a>
DNA damage, comet assay (strand breaks and FPG-sensitive sites), human HepG2 cells	-	NT	165.6	<a href="#">Eriksen et al. (2010)</a>
DNA damage, comet assay, human HepG2 cells	-	NT	165.6	<a href="#">Florentin et al. (2011)</a>
Chromosomal aberrations, human lymphocytes	-	-	1510	<a href="#">Muri (1996a)</a>
Micronucleus formation, human hepatoma HepG2 cells	+	NT	41.5	<a href="#">Yao &amp; Zhong (2005)</a>
Micronucleus formation, human HepG2 cells	-	NT	165.6	<a href="#">Florentin et al. (2011)</a>
Gene mutation, normal human-hamster hybrid cells (A <sub>1</sub> ) <sup>c</sup>	+	NT	83	<a href="#">Zhao et al. (2011)</a>
Gene mutation, mitochondrial DNA-deficient human-hamster hybrid cells (p° A <sub>1</sub> )	-	NT	83	<a href="#">Zhao et al. (2011)</a>
<b>Mammalian systems in vitro</b>				
Gene mutation, <i>Hprt</i> locus, K-1 Chinese hamster ovary cells	-	-	39	<a href="#">Sadhua (2002)</a>
Chromosomal aberrations, Chinese hamster ovary cells	- <sup>e</sup>	+	2500 <sup>f</sup>	<a href="#">Muri (1996b)</a>
Chromosomal aberrations, Chinese hamster ovary cells	(+) <sup>g</sup>	+	4970 <sup>h</sup>	<a href="#">Muri (1996c)</a>
Polyploidy, Chinese hamster ovary cells	-	+	2250 <sup>i</sup>	<a href="#">Muri (1996b)</a>
Polyploidy, Chinese hamster ovary cells	+	+ <sup>k</sup>	3740	<a href="#">Muri (1996c)</a>
Cell transformation, C3H10T½ mouse embryo fibroblasts	-	NT	200	<a href="#">EPA (1981)</a>
<b>Mammalian systems in vivo</b>				
Micronucleus, mouse bone marrow, polychromatic erythrocytes	-	NA	5000	<a href="#">Muri (1995)</a>
Micronucleus formation, mouse bone marrow, polychromatic erythrocytes	-	NA	950 p.o. x1	<a href="#">Muri (1996d)</a>
8-hydroxydeoxyguanosine, male Fischer 344 rats, liver	+	NA	100 i.p. x1	<a href="#">Takagi et al. (1991)</a>
8-hydroxydeoxyguanosine, male Fischer 344 rats, kidney	-	NA	100 i.p. x1	<a href="#">Takagi et al. (1991)</a>
8-hydroxydeoxyguanosine, male Fischer 344 rats, liver	+	NA	0.02% diet, 2 wk	<a href="#">Takagi et al. (1991)</a>
8-hydroxydeoxyguanosine, male Fischer 344 rats, kidney	-	NA	0.02% diet, 2 wk	<a href="#">Takagi et al. (1991)</a>

Table 4.2 (continued)

Test system	Results <sup>a</sup>		Dose <sup>b</sup> (LED or HID)	Reference
	Without exogenous metabolic system	With exogenous metabolic system		
<b>Non-mammalian eukaryotic systems in vitro</b>				
Gene mutation, <i>Saccharomyces cerevisiae</i>	-	-	500	<a href="#">Griffith &amp; Long (1980)</a>
DNA damage, comet assay (pH 13), paramécia <i>Paramecium caudatum</i>	+ <sup>1</sup>	NT	41.5	<a href="#">Kawamoto et al. (2010)</a>
DNA damage, comet assay (pH 12.1), paramécia <i>Paramecium caudatum</i>	-	NT	41.5	<a href="#">Kawamoto et al. (2010)</a>
8-OHdG, paramécia <i>Paramecium caudatum</i>	-	NT	41.5	<a href="#">Kawamoto et al. (2010)</a>
<b>Prokaryote (bacteria)</b>				
Gene mutation, <i>Salmonella typhimurium</i> TA98, TA100, TA1535, TA1537, TA1538	-	-	1000	<a href="#">Griffith &amp; Long (1980)</a>
Gene mutation, reverse mutation <i>Salmonella typhimurium</i> TA98, TA100, TA1535, TA1537	- <sup>m</sup>	-	5000 µg/plate	<a href="#">Lawlor (1995, 1996)</a>
Gene mutation, <i>Salmonella typhimurium</i> TA1535/pSK1002 ( <i>hisG46</i> , <i>rfa</i> , <i>uvrB</i> ), <i>umu</i> test	-	-	414	<a href="#">Oda et al. (2007)</a>
Gene mutation, reverse mutation <i>Salmonella typhimurium</i> TA98, TA100, TA102, TA104	-	-	207	<a href="#">Fernández Freire et al. (2008)</a>
Gene mutation, <i>Escherichia coli</i> WP2 <i>uvrA</i>	-	-	5000 µg/plate	<a href="#">Lawlor (1995, 1996)</a>

<sup>a</sup> +, positive; (+), weakly positive; -, negative; NA, not applicable; NT, not tested

<sup>b</sup> LED, lowest effective dose; HID, highest ineffective dose; in-vitro tests, µg/mL; in-vivo tests, mg/kg bw per day; inh, inhalation; p.o., oral; i.p., intraperitoneal

<sup>c</sup> A<sub>1</sub> cells contain a standard set of CHO-K1 chromosomes and a single copy of human chromosome 11. Chromosome 11 contains the *CD59* gene (also known as *MIC1*) at 11p13.5.

<sup>d</sup> This gene encodes the CD59 cell-surface antigen marker (formerly known as S1) that renders A<sub>1</sub> cells sensitive to killing by monoclonal antibodies E7.1 in the presence of rabbit serum complement

<sup>e</sup> Levels of reactive oxygen species (ROS) increased after 1 day of treatment with PFOA at 100 µM (no further increases at concentrations > 100 µM or with longer exposure time). ROS inhibitor decreased the mutagenic effects of PFOA. PFOA increased intracellular ROS, NO, and O<sub>2</sub> production in AL cells. Caspase activities in AL cells were increased by PFOA and suppressed by inhibitors of ROS/nitrogen species. Results suggested that mitochondria-dependent ROS plays an important role in PFOA mutagenic effects observed in AL cells after long treatment (18 or 42 hours) and harvest time 20 or 44 hours after initiation of treatment, respectively; tested up to 2000 µg/mL

<sup>f</sup> LED in 3-hour treatment with S9, and harvest time 20 hours after initiation of treatment

<sup>g</sup> After short treatment (3 hours) and harvesting 44 hours after initiation of treatment, only at highest dose of 3740 µg/mL

<sup>h</sup> LED in 3-hour treatment with S9, and harvesting 20 hours after initiation of treatment (this treatment caused a 70% decrease in cell confluence, but an acceptable 43% decrease in mitotic index). An increase in chromosomal aberrations observed at 3730 µg/mL was not reproducible

<sup>i</sup> LED after 44 hours treatment

<sup>j</sup> In 3-hour treatment and harvesting 44 hour after initiation of treatment; LED, 3740 µg/mL

<sup>k</sup> In 3-hour treatment with S9 and harvesting 44 hours after initiation of treatment; LED, 4970 µg/mL. Toxicity prevented scoring of chromosomal aberration at this concentration, for this treatment

<sup>l</sup> An increase in intracellular ROS generation was also observed. Addition of glutathione inhibited PFOA-induced ROS, but did not abolish the DNA damage observed

<sup>m</sup> A significant increase observed at one dose in TA1537 without S9-mix was not reproduced in a repeat experiment ([Lawlor, 1996](#)).

tested with or without metabolic activation in the K-1 line of Chinese hamster ovary (CHO-K1) cells in culture.

(ii) *Chromosomal aberration*

PFOA was tested twice for its ability to induce chromosomal aberrations in CHO cells (Murli, 1996b, c). In the first assay, PFOA induced chromosomal aberrations and polyploidy in the presence and absence of metabolic activation (Murli, 1996c), while in the second assay it induced chromosomal aberrations and polyploidy only in the presence of metabolic activation (Murli, 1996b). These effects were observed only at toxic concentrations, which caused up to 70% decrease in cell monolayer confluence, but acceptable decrease in mitotic index (Murli, 1996b, c).

(iii) *Micronucleus formation*

PFOA did not induce a significant increase in micronucleus formation when tested twice in an in-vivo micronucleus assay in bone marrow in mice at a single oral dose of 5000 mg/kg bw (Murli, 1995, 1996d).

(iv) *DNA binding and other DNA damage*

In-vivo administration of PFOA as a single intraperitoneal injection at 100 mg/kg bw in male Fischer 344 rats induced an increase in the levels of 8-OH-dG in liver DNA, but not in kidney DNA (Takagi et al., 1991). In male Fischer 344 rats, feeding with diets containing PFOA at concentrations of 0.02% for 2 weeks induced hepatomegaly and also increased the levels of 8-OH-dG in liver DNA, but not in kidney DNA (Takagi et al., 1991).

(v) *Cell transformation*

PFOA did not induce cell transformation in C3H10T½ mouse embryo fibroblasts (EPA, 1981).

(b) *Non-mammalian eukaryotic system: DNA damage*

Kawamoto et al. (2010) showed that PFOA induced DNA damage in the comet assay in paramecia *Paramecium caudatum* at pH 13, but not at pH 12.1, which suggested that the damage may be due to alkali-labile sites. The study also demonstrated an increase in ROS generation, while the level of 8-OHdG remained unchanged. Moreover, addition of glutathione inhibited the PFOA-induced ROS, but did not abolish the DNA damage observed.

(c) *Bacterial and other systems: gene mutation*

PFOA did not induce mutation in either *Salmonella typhimurium* or *Escherichia coli* when tested either with or without metabolic activation (Griffith & Long, 1980; Lawlor, 1995, 1996). PFOA was not mutagenic with or without metabolic activation in *S. typhimurium* strains TA98, TA100, TA102, and TA104 (Fernández Freire et al., 2008). PFOA was not mutagenic in *S. typhimurium* TA1535/pSK1002 (*hisG46*, *rfa*, *uvrB*) with or without metabolic activation, using the umu test (Oda et al., 2007). PFOA did not induce mutation in *S. cerevisiae* with or without metabolic activation (Griffith & Long, 1980).

## 4.3 Other mechanistic data relevant to carcinogenesis

### 4.3.1 Mammary gland

(a) *Humans*

No data were available to the Working Group.

(b) *Experimental animals*

Zhao et al. (2010b) exposed C57BL/6 wild-type and C57BL/6 PPARα null mice to deionized water (control) or to PFOA (5 mg/kg bw) by oral gavage once daily for 5 days per week, for 4 weeks, starting at age 21 days. Both wild-type and null mice had elevated levels of several

growth factors in the mammary gland, including epidermal growth factor, estrogen, and proliferating cell nuclear antigen. [The Working Group noted that these data illustrate that PFOA affects the mammary gland in a manner independent of peroxisome proliferator-activated receptor  $\alpha$  (PPAR $\alpha$ ) involvement.]

#### 4.3.2 Kidney

##### (a) Humans

No data were available to the Working Group.

##### (b) Experimental animals

Palmitoyl CoA oxidation and carnitine acetyl transferase activity, enzyme markers of peroxisome proliferation, were elevated in the kidney of male Wistar rats given PFOA as a single intraperitoneal injection at 75 mg/kg bw ([Diaz et al., 1994](#)). The same study also reported an increase in the activity, mRNA, and protein expression of the cytochrome CYP4A subfamily, which is an effect that is typical of peroxisome proliferating compounds in the kidney.

In the monkey kidney-derived Vero cell line, [Fernández Freire et al. \(2008\)](#) showed that high concentrations of PFOA (500  $\mu$ M) cause oxidative stress, which was closely linked to cell cycle arrest and induction of apoptosis.

#### 4.3.3 Liver

Numerous studies have suggested several mechanisms for the observed PFOA-induced toxicity in the liver in human cells, and in experimental animal models and cells, including PPAR $\alpha$  activation (as measured by changes in PPAR $\alpha$ -related gene expression), peroxisome proliferation (as represented by increases in enzymes associated with  $\beta$ -peroxisomal oxidation), and oxidative stress. The following section is arranged by these putative mechanisms.

##### (a) PPAR $\alpha$ activation

###### (i) Humans

In-vitro studies in primary human hepatocytes or cell lines transfected with human PPAR $\alpha$  have demonstrated that PFOA can activate human PPAR $\alpha$ , as measured by changes in PPAR $\alpha$ -related gene expression, but at doses higher than those required to activate rodent PPAR $\alpha$ . Cultured human hepatocytes were exposed to various concentrations of PFOA (0–200  $\mu$ M), and induction of several PPAR $\alpha$ -related genes was observed ([Bjork & Wallace, 2009](#); [Bjork et al., 2011](#)). Additionally, a study by [Bjork et al. \(2011\)](#) demonstrated that a relatively low dose (25  $\mu$ M) was sufficient to induce PPAR $\alpha$ -related genes. Of note was that these responses were not as pronounced as those observed in primary rat hepatocytes. [Takacs & Abbott \(2007\)](#) demonstrated that PFOA activated human PPAR $\alpha$ , but at a concentration ~200% greater than the lowest effective concentration required to activate mouse PPAR $\alpha$ . [Wolf et al. \(2012\)](#) reported similar results in a luciferase reporter assay with mouse and human PPAR $\alpha$ . [The Working Group noted that these studies demonstrated that human PPAR $\alpha$  may be activated by PFOA exposure, but at much higher concentrations than those required to activate rodent PPAR $\alpha$ .] Additional data on various human PPAR transactivation assays are presented in Section 4.3.3(b).

###### (ii) Experimental animals

###### Rats

[Ren et al. \(2009\)](#) performed a meta-analysis of transcript profiles from published studies of rats exposed to PFOA and confirmed that exposure to PFOA activates PPAR $\alpha$  in the rat liver. [Bjork & Wallace \(2009\)](#) and [Bjork et al. \(2011\)](#) exposed cultured rat hepatocytes to various concentrations of PFOA (up to 200  $\mu$ M), and observed induction of PPAR $\alpha$ -related genes. Additionally, a study by [Bjork et al. \(2011\)](#) demonstrated that

a relatively low dose of PFOA (25 µM) was sufficient to induce PPAR $\alpha$ -related genes.

#### Mice

[Lee et al. \(1995\)](#) developed a transgenic mouse (Sv/129  $\times$  C57BL/6N) model with a disruption in the ligand-binding domain of PPAR $\alpha$ . Male mice with this mutation fed diets containing peroxisome-proliferating chemicals (clofibrate, a pharmaceutical agent, and Wy-14 643) for 2 weeks had peroxisomes, but failed to display peroxisome proliferation. [Rosen et al. \(2008a\)](#) demonstrated that in wild-type and PPAR $\alpha$ -null mice exposed to PFOA (1 or 3 mg/kg for 7 days), most genes whose transcripts were altered in the livers of wild-type mice were done so through PPAR $\alpha$  activation; changes in livers of PPAR $\alpha$ -null mice were likely to be attributable to other receptors, including other isoforms of PPAR. However, no clear data on an association between carcinogenesis and PPAR $\alpha$  target genes were provided.

[Nakamura et al. \(2009\)](#) exposed 129/Sv wild-type, PPAR $\alpha$ -null, and mice with a humanized PPAR $\alpha$  to ammonium perfluorooctanoate at a oral dose of 0.1 or 0.3 mg/kg for 2 weeks. Expression of PPAR $\alpha$  target genes or proteins in the livers of mice with a humanized PPAR $\alpha$  was not altered by exposure. However, [Nakagawa et al. \(2012\)](#) reported that PFOA at a dose of 1 or 5 mg/kg was sufficient to activate PPAR $\alpha$  in mice with a humanized PPAR $\alpha$ , although the activation was less than that observed for mouse PPAR $\alpha$ .

#### (b) Peroxisome proliferation

##### (i) Humans

No data were available to the Working Group.

##### (ii) Experimental animals

#### Non-human primates

Male cynomolgus monkeys were given daily oral doses of ammonium perfluorooctanoate at 0, 3, 10, or 20 mg/kg bw per day of for 26 weeks

([Butenhoff et al., 2002](#)). Livers from monkeys in the group at the highest dose had statistically significant increases in palmitoyl CoA oxidation.

#### Rats

Long-term exposure to PFOA in rats has been associated with increases in peroxisome proliferating enzymes. In a 2-year study designed to evaluate mechanisms associated with PFOA-induced tumour production, [Biegel et al. \(2001\)](#) fed male CD rats with PFOA at 300 ppm or Wy 14 643 (a known PPAR $\alpha$  agonist) at 50 ppm. Hepatic  $\beta$ -oxidation was increased by exposure to Wy 14 643 and PFOA.

Short-term exposures to PFOA in rats also have been associated with increases in peroxisome proliferating enzymes. Male and female Wistar rats given diet containing PFOA at ~15 mg/kg for 2 or 26 weeks had elevated levels of peroxisomal  $\beta$  oxidation at both time-points ([Kawashima et al., 1994](#)). Elevation of peroxisomal enzymes in males was ~375% greater than in controls after 2 weeks of exposure; female levels were only ~50% greater than in controls. After 26 weeks of exposure, peroxisomal-enzyme levels in males were ~200% greater and in females were ~60% greater relative to controls. Males also had elevated microsomal content of cytochrome P450 ([Kawashima et al., 1994](#)). Male Wistar rats given diet containing PFOA at ~15 mg/kg for 2 or 26 weeks had a marked increase in peroxisomal  $\beta$ -oxidation at all administered doses ([Uy-Yu et al., 1990](#)). Females exposed to the same dose and duration had mild, but statistically significant, increases in peroxisomal  $\beta$ -oxidation only at the two higher doses administered ([Uy-Yu et al., 1990](#)).

Short-term exposures to PFOA in rats also have been associated with increases in peroxisome proliferating enzymes. [Elcombe et al. \(2010\)](#) gave male Sprague-Dawley rats diet containing ammonium perfluorooctanoate at 300 ppm (15 mg/kg) for 1, 7, or 28 days. Palmitoyl CoA oxidase activity was increased by approximately

8- and 10-fold after 7 or 28 days of exposure, respectively. Additionally, exposure at all durations led to increases in CYP4A1 protein levels ([Elcombe et al., 2010](#)). Peroxisomal enzymes in male Wistar rats fed diet containing PFOA at 3.75–60 mg/kg for 1 week increased in a dose-dependent manner ([Kawashima et al., 1995](#)). Induction of peroxisomal  $\beta$ -oxidation occurred in male Fischer 344 rats after a single dose of PFOA at 150 mg/kg bw by gavage; induction occurred rapidly after exposure and remained elevated up to 5 days after exposure in rats of various ages ([Badr & Birnbaum, 2004](#)). A study by [Thottassery et al. \(1992\)](#) demonstrated that a single oral dose of PFOA (150 mg/kg bw) administered to male Sprague-Dawley rats resulted in induction of peroxisome proliferation in centrilobular regions of the liver lobule; increases in cell proliferation were mostly periportal. Male Wistar rats given a single intraperitoneal injection of PFOA at 75 mg/kg bw and killed three days after exposure had elevated palmitoyl CoA oxidation, elevated carnitine acetyl transferase activity, and increases in activity, mRNA, and protein expression of the cytochrome CYP4A subfamily ([Diaz et al., 1994](#)).

Additional long-term studies using initiation–selection–promotion protocols also demonstrated increases in peroxisome proliferating enzymes. In a pair of studies with initiation–selection–promotion protocols for induction of tumours of the liver, adult male Wistar rats given diet containing PFOA at 0.015% for 7 months showed increased levels of peroxisomal enzymes and peroxisomal  $\beta$ -oxidation ([Abdellatif et al. 1990, 1991](#)). [Nilsson et al. \(1991\)](#) used an identical initiation–selection–promotion protocol in male Wistar rats, followed by diet containing 0.015% PFOA for 7 months and, in agreement with the studies by [Abdellatif et al. \(1990, 1991\)](#), reported that PFOA acted as a promoter of tumours of the liver, and that promotion was associated with increases in peroxisomal-enzyme activity. In a follow-up study, [Abdellatif et al. \(2003\)](#) evaluated

the tumour-promoting activity of PFOA with a biphasic protocol (initiation followed by dietary PFOA at 0.005% or 0.02%, for 14 and 25 weeks) or a triphasic protocol (initiation, selection–promotion followed by dietary PFOA at 0.015%, for 25 weeks). PFOA exposure induced fatty acyl CoA oxidase, a peroxisomal-enzyme marker for PPAR $\alpha$  activation.

Finally, a study in Rat Morris hepatoma 7800C1 cells (a rat liver cell line) exposed to culture medium containing PFOA at 500  $\mu$ M for 7 days demonstrated induction of peroxisomal enzymes and CYP4A ([Sohlenius et al., 1994](#)).

#### Mice

[Sohlenius et al. \(1992a, b\)](#) evaluated the effects of dietary administration of PFOA (0.02–0.05%) in male and female C57BL/6 mice exposed for 5 or up to 10 days. Increases (> 1000% over control levels) in peroxisomal enzymes were observed for all groups of exposed mice; differences between responses in male and female mice were not observed. Five days of exposure to PFOA at 0.05% led to an increase in peroxisomal enzyme activity that persisted for up to 20 days after exposure.

[Lee et al. \(1995\)](#) developed a transgenic mouse (Sv/129  $\times$  C57BL/6N) model with a disruption to the ligand-binding domain of PPAR $\alpha$ . Male mice with this mutation fed diets containing peroxisome proliferating chemicals for 2 weeks failed to display transcriptional activation of PPAR $\alpha$  target genes.

#### (c) Activation of other nuclear receptors

##### (i) Humans

Cultured human hepatocytes exposed to PFOA at various concentrations (0–200  $\mu$ M) showed an induction of the liver X receptor  $\alpha$  (LXR $\alpha$ ) ([Bjork & Wallace, 2009](#); [Bjork et al., 2011](#)). This response was not as pronounced as that observed in primary rat hepatocytes. Of note was that similarly exposed rat hepatocytes showed induction of constitutive androstane

receptor (CAR) and pregnane X receptor (PXR), in addition to LXR $\alpha$ .

(ii) *Experimental animals*

*Rats*

Several studies have explored the involvement of additional nuclear receptors and/or transcription factors in carcinogenicity associated with exposure to PFOA. [Elcombe et al. \(2010\)](#) gave male Sprague-Dawley rats diets containing ammonium perfluorooctanoate at a concentration of 300 ppm (15 mg/kg) or Wy 14 643 at 50 ppm for 1, 7, or 28 days. Ammonium perfluorooctanoate caused increased expression of genetic markers of activation for CAR and CAR/PXR.

[Bjork et al. \(2011\)](#) exposed cultured rat hepatocytes to PFOA at various concentrations up to 200  $\mu$ M, and observed robust induction of not only PPAR $\alpha$ -related genes, but genes associated with the nuclear receptors CAR, PXR, and LXR $\alpha$ . These receptors, like PPAR $\alpha$ , play a role in fatty acid metabolism.

*Mice*

[Rosen et al. \(2008a, b\)](#) compared transcript profiles of livers from mice exposed by gavage for 7 days to PFOA (1 or 3 mg/kg) or Wy 14 643 (50 mg/kg), including livers from PPAR $\alpha$ -null mice. In wild-type mice, it appeared that expression of most genes was altered by PFOA through PPAR $\alpha$ ; however, in PPAR $\alpha$ -null mice, a subset of genes appeared to be altered in expression by PFOA through CAR and possibly PPAR $\gamma$ .

*Fish*

Several long-term and short-term dietary studies with PFOA in trout (*Oncorhynchus mykiss*), a species that generally does not experience liver peroxisome proliferation, demonstrated concomitant induction of estrogen receptor-responsive genes and proteins in the liver, and tumours of the liver ([Tilton et al., 2008](#); [Benninghoff et al., 2011, 2012](#)). Studies with other species of freshwater fish (rare minnow

and tilapia) have demonstrated that short-term dietary exposure to PFOA induces estrogen receptor-responsive genes and proteins in the liver ([Liu et al., 2007a](#); [Wei et al., 2007, 2008](#)).

(d) *Oxidative stress*

(i) *Humans*

Several studies in human cell lines or cells transfected with human receptors also have evaluated the ability of PFOA to induce oxidative stress. [Panaretakis et al. \(2001\)](#) exposed human HepG2 cells to PFOA at 200 or 400  $\mu$ M (1.5–24 hours) and reported increased formation of ROS, with a peak at 3 hours. However, [Eriksen et al. \(2010\)](#) exposed human HepG2 cells to PFOA at varying concentrations (0.4–2000  $\mu$ M) and reported a statistically significant, but relatively modest increase in ROS. Additionally, [Florentin et al. \(2011\)](#) exposed human HepG2 cells to PFOA at several concentrations (5–800  $\mu$ M) and did not observe significant changes in ROS generation. A study with a human–hamster hybrid cell line reported induction of ROS after 16 days of exposure to PFOA at 200  $\mu$ M ([Zhao et al., 2011](#)).

(ii) *Experimental animals*

*Increased production of ROS*

Several studies in rats and mice examined markers of increased production of ROS after exposure to PFOA. Male Wistar rats fed diets containing PFOA at a concentration of ~15 mg/kg (0.01%) for 26 weeks had an imbalance of metabolism of hydrogen and lipid peroxides ([Kawashima et al., 1994](#)). In male F344 rats given diet containing PFOA at a concentration of ~30 mg/kg (0.02%) for 2 weeks, 8-OH-dG levels were increased in liver DNA ([Takagi et al., 1991](#)). Similarly, 8-OH-dG levels in liver DNA were increased 1, 3, 5, or 8 days after a single intraperitoneal dose of PFOA of 100 mg/kg bw ([Takagi et al., 1991](#)). Male C57BL/6 mice given diet containing PFOA at a concentration of ~30 mg/kg (0.02%) for 2 weeks had increased



lipid peroxidation in liver microsomes, as measured by ADP-Fe<sup>3+</sup>-NADPH-dependent consumption of oxygen (Cai et al., 1995).

Liu et al. (2007a) observed induction of oxidative stress in primary cultured liver cells from freshwater tilapia (*Oreochromis niloticus*) exposed 24 hours to 15 or 30 mg/L of PFOA.

#### Decreased antioxidant capacity

Badr & Birnbaum (2004) found that the effects of PFOA on oxidative stress in the liver in male F344 rats were modulated with age; after a single oral dose of 150 mg/kg bw of PFOA, the ratio of hepatic peroxisomal  $\beta$ -oxidation to liver catalase activity increased as animals aged.

In male Japanese medaka fish (*Oryzias latipes*), exposure to PFOA at a concentration of 50 or 100 mg/L caused decreases in the antioxidant activity of catalase in the liver, suggesting that PFOA may cause oxidative stress in the liver (Yang, 2010).

#### Mitochondrial dysfunction

Mitochondrial dysfunction also may contribute to oxidative stress associated with exposure to PFOA. In male Sprague-Dawley rats treated with PFOA at a dose of 30 mg/kg bw by gavage for 28 days, PFOA stimulated mitochondrial biogenesis or inhibited mitochondrial metabolism in the liver, which may contribute to metabolic imbalance (Walters & Wallace, 2010).

Male zebrafish (*Danio rerio*) exposed to PFOA at a concentration of 1 mg/L for 14 days had decreased liver mitochondrial electron-transport activity (Hagenaars et al., 2013).

#### 4.3.4 Pancreas

No studies in humans and a single study in experimental animals have addressed biochemical and cellular effects in relation to pancreatic carcinogenicity associated with exposure to PFOA.

In a 2-year study in which male CD rats were fed ammonium perfluorooctanoate at 300

ppm or Wy 14 643 (a known PPAR $\alpha$  agonist) at 50 ppm, pancreatic acinar cell proliferation was increased by ammonium perfluorooctanoate but not by Wy 14 643, although both compounds produced increases in acinar cell hyperplasia (Biegel et al., 2001).

#### 4.3.5 Testes (Leydig cells)

Interference with steroidogenic enzymes is a putative mechanism that may result in testicular carcinogenesis.

##### (a) Humans

No studies examining interference with steroidogenic enzymes in humans exposed to PFOA were available to the Working Group.

##### (b) Experimental animals

###### (i) Non-human primates

Male cynomolgus monkeys were given ammonium perfluorooctanoate at daily oral doses of 0, 3, 10, or 20 mg/kg bw per day for 26 weeks (Butenhoff et al., 2002). Testicular cell proliferation, as measured by a proliferating cell nuclear antigen assay, was not affected by treatment with PFOA.

###### (ii) Rats

In a 2-year study in which male CD rats were fed diets containing ammonium perfluorooctanoate at a concentration of 300 ppm or Wy 14 643 (a known PPAR $\alpha$  agonist) at 50 ppm, levels of serum estradiol and Leydig cell hyperplasia were increased by Wy 14 643 and PFOA (Biegel et al., 2001). Similarly, in a 14-day study, levels of serum estradiol in male CD rats given PFOA at a dose of 10, 25, or 50 mg/kg bw by gavage were elevated relative to levels in controls (Cook et al., 1992). In an additional group of rats exposed to ammonium perfluorooctanoate at a dose of 50 mg/kg bw for 14 days and challenged with human chorionic gonadotropin 1 hour before killing (to maximize increases in serum

testosterone), [Cook et al. \(1992\)](#) reported a 50% reduction in serum testosterone levels relative to those in controls. In a follow-up study, serum estradiol, transforming growth factor  $\alpha$  (TGF $\alpha$ ), and estradiol in testicular interstitial fluid were found to be elevated in rats given ammonium perfluorooctanoate at a dose of 25 mg/kg bw by gavage for 14 days, relative to pair-fed controls ([Biegel et al., 1995](#)). Additionally, liver aromatase activity was 4.5-fold that of pair-fed controls.

[Biegel et al. \(1995\)](#) also examined the effects of ammonium perfluorooctanoate on Leydig cells isolated from CD rats. Leydig cells were treated in vitro with PFOA at a concentration of 100–1000  $\mu$ M for 2 hours. Leydig cells were also isolated from rats treated in vivo with PFOA at 25 mg/kg by gavage. Both sets of cells were stimulated with human chorionic gonadotropin; cells treated in vitro showed a dose-related decrease in testosterone production, while cell isolated from animals treated in vivo showed an increase in testosterone production. In another study, [Zhao et al. \(2010a\)](#) cultured Leydig cells from Sprague-Dawley rats for 24 hours with PFOA at 10 or 100  $\mu$ M, and exposed testicular microsomes from Sprague-Dawley rats to PFOA at concentrations of up to 100  $\mu$ M. Both exhibited inhibition of 3-beta-hydroxysteroid dehydrogenase and 17-beta-hydroxysteroid dehydrogenase 3, enzymes that are involved in testosterone biosynthesis. Additionally, Leydig cells that had been exposed to PFOA failed to produce increases in testosterone relative to stimulated control cells when stimulated with luteinizing hormone.

#### 4.3.6 Other target organs

Although the bladder and prostate gland were identified as tumour sites targeted by exposure to PFOA, no studies on potential biochemical or cellular effects were available to the Working Group.

A limited number of epidemiological studies in humans have evaluated thyroid hormone

concentrations, thyroid gland function, and thyroid disease associated with exposure to PFOA (discussed in Section 4.4.5). No studies in humans or experimental animals addressing biochemical and cellular effects in the thyroid gland were available to the Working Group.

#### 4.3.7 Modulation of inflammatory pathways

It has been suggested that modulation of inflammatory pathways is a mechanism underlying PFOA-induced carcinogenesis. In one study, [Qazi et al. \(2009\)](#) reported increases in serum levels of interleukin-6 (IL-6) and tumour necrosis factor  $\alpha$  (TNF $\alpha$ ) – cytokines that induce inflammation– in mice fed diets containing PFOA (0.02%) for 10 days after stimulation of inflammation with lipopolysaccharide (100 ng/mL). However, in a series of in-vitro assays, [Corsini et al. \(2011, 2012\)](#) reported that PFOA (0.1–10  $\mu$ g/mL) was the least potent of a suite of perfluoroalkyl substances to alter lipopolysaccharide-stimulated release of IL-6 and TNF $\alpha$ . PFOA binds to PPAR $\alpha$  and a significant number of PPAR $\alpha$  agonists have been shown to reduce inflammation ([Griesbacher et al., 2008](#)). [As markers of inflammatory processes, it would be expected that TNF $\alpha$  and IL-6 would decrease after exposure to PFOA. However differences in dose, rodent strain, cell type, and receptor affinity make it difficult to predict whether exposure to PFOA would lead to chronic inflammation and contribute to carcinogenicity risk via this pathway.]

#### 4.3.8 Nuclear receptors

PFOA and its ammonium salt have been tested in a large number of high-throughput screening assays in the Toxicity Forecaster (ToxCast) and Toxicity Testing in the 21st Century (Tox21) research programmes of the government of the USA ([Kavlock et al., 2012](#); [Tice et al., 2013](#)). The data from these programmes are publicly

available through the iCSS dashboard ([ToxCast, 2014](#)) Specifically, data on 821 assays and 1858 chemicals were publicly available through the iCSS Dashboard v0.5 as of 1 June 2014. [The Working Group used this information to examine the molecular targets affected by PFOA and its ammonium salt, and to compare the molecular signatures with those of several prototypical nuclear receptor activators: rifampicin (CAS No. 13292-46-1; PXR), phenobarbital (CAS No. 57-30-7; CAR), and di(2-ethylhexyl)phthalate (CAS No. 117-81-7; peroxisome proliferator response elements) and mono(2-ethylhexyl)phthalate (MEHP) (CAS No. 4376-20-9; PPARs). Data on all assays for these six compounds were downloaded. Assays in which all of the six compounds were inactive (as indicated by an altering concentration [AC]50 value of 1000), or in which any of the compounds were not tested, were removed and the results of the remaining 37 assays (about 4.5% of the total) were analysed. These included cell-free enzymatic and ligand-binding high-throughput screening assays (labelled “NVS”) ([Sipes et al., 2013](#)), cell-based nuclear receptors and transcription-factor response element assays (labelled “ATG”) ([Martin et al., 2010](#)), and Tox21 robotic platform high-throughput assays (labelled “Tox21”) ([Attene-Ramos et al., 2013](#)). Most of these assays were designed for human enzymes and transcription factors.

AC50 values downloaded from the database were derived from quantitative concentration–response modelling using Hill function based on 7–10 concentrations spanning several orders of magnitude, ranging from low nanomolar to ~200  $\mu\text{M}$ . Each chemical and assay had one AC50 value (ranging from 1000 indicating “inactive”, to 2.6 nM indicating the most potent response) that was used to create plots displayed in [Fig. 4.1](#), Panels A–F. The data on 37 assays were subdivided into 6 groups by the molecular targets as follows: estrogen receptor assays (panel A), PPAR assays (panel B), PXR assays (panel C), aromatase

assays (panel D), enzyme assays (panel E), and other (panel F).

[The Working Group interpreted the outcome of this analysis to indicate that great similarity exists across the assays in responses elicited by PFOA and its ammonium salt. At the same time, it was apparent that the responses of these two compounds are distinct from those of other prototypical activators of nuclear receptors CAR, PXR, and PPARs. This outcome is consistent with observations that multiple nuclear receptors are activated by PFOA in vivo in rodents ([Rosen et al., 2008b](#); [Elcombe et al., 2010](#)). Additionally, the Working Group noted that, unlike the selected comparison compounds, PFOA and its ammonium salt appeared to be consistently active in estrogen receptor assays, in keeping with observations on effects on reproductive hormones and tissues ([Cook et al., 1992](#); [Biegel et al., 1995](#); [Yang et al., 2009b](#); [Zhao et al., 2010a, b](#)].

Additional studies have evaluated the ability of PFOA to activate estrogen receptors (including ER $\alpha$  and ER $\beta$ ) in a variety of in-vitro assays. In a yeast two-hybrid assay with human ER $\alpha$  and ER $\beta$ , [Ishibashi et al. \(2007\)](#) reported that exposing these cells to PFOA did not increase transcriptional activity of ERs. However, in a separate study of PFOA-exposed human embryonic kidney (HEK-293T) cells, [Benninghoff et al. \(2011\)](#) reported induction of ER $\alpha$  gene reporter activity. Two studies with MCF-7 human breast cancer cells ([Maras et al., 2006](#); [Henry & Fair, 2013](#)) demonstrated that PFOA was estrogenic via an E-SCREEN assay, an assay designed to use the estrogen sensitivity of MCF-7 to determine effects of exogenous agents on cell proliferation ([Henry & Fair, 2013](#)). [Maras et al. \(2006\)](#) also reported that PFOA induced a small upregulation in the expression of estrogen-responsive genes ([Maras et al., 2006](#)).

**Fig. 4.1 Comparison of in-vitro screening results for perfluorooctanoic acid (PFOA) with those of several prototypical nuclear receptor-activating compounds**

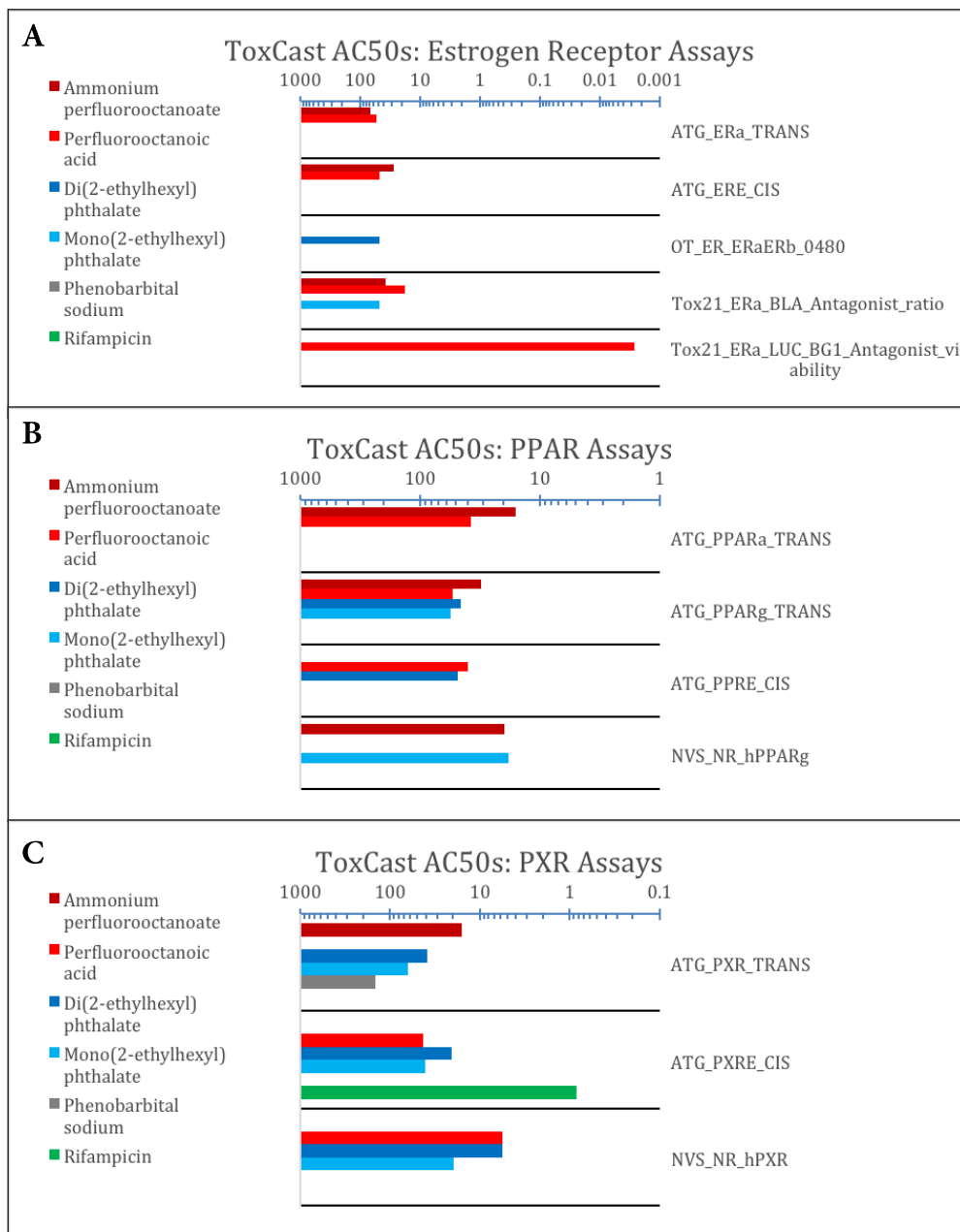

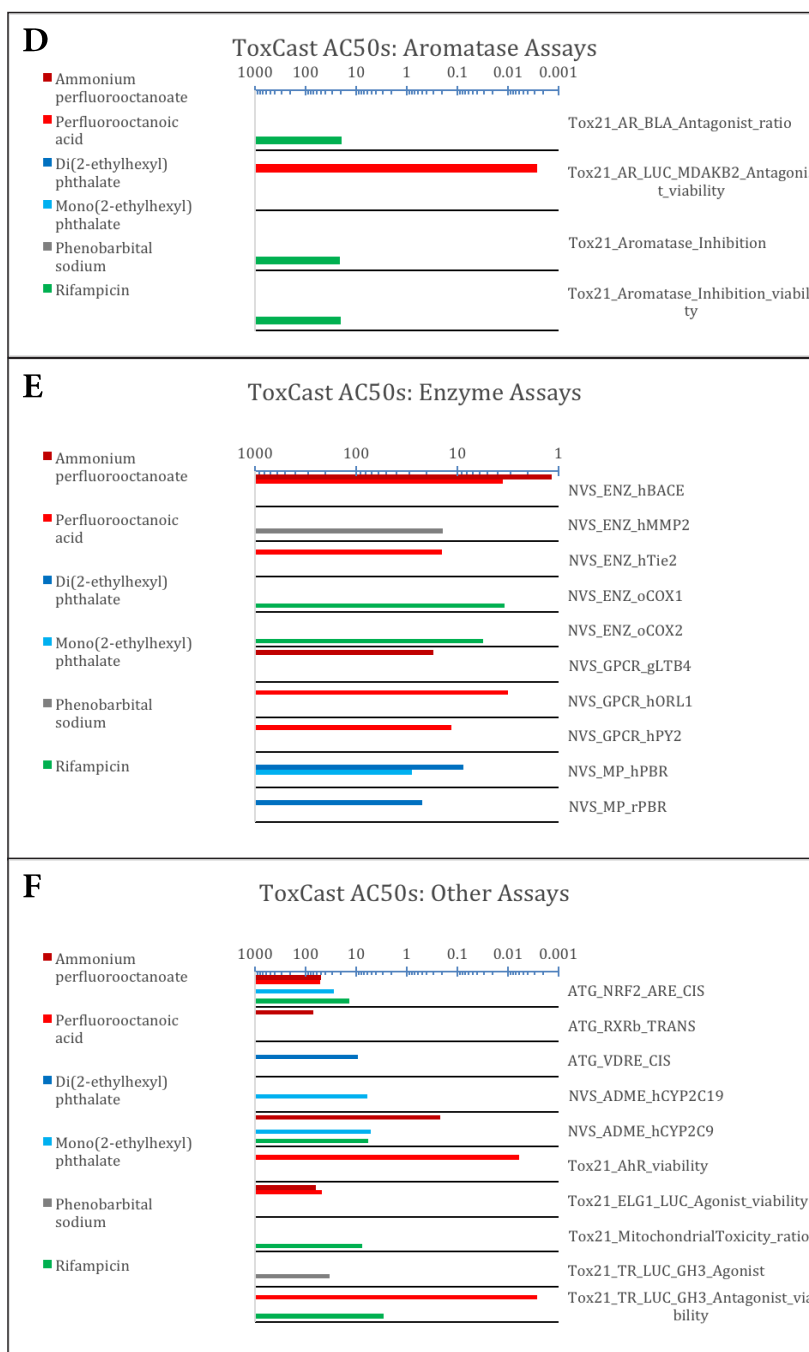

Specifically, each panel shows AC50s (micromolar concentrations) from in-vitro assays reported on the United States Environmental Protection Agency CSS Dashboard (<http://actor.epa.gov/dashboard/>) for PFOA or its ammonium salt and several prototypical nuclear receptor activators: rifampicin (pregnane X receptor, PXR), phenobarbital (constitutive androstane receptor, CAR), and di(2-ethylhexyl)phthalate (peroxisome proliferator-activated receptor response elements) and mono(2-ethylhexyl)phthalate (peroxisome proliferator-activated receptors, PPARs). All assays in which positive results were obtained for at least one of the six compounds are shown. Results were subdivided into six groups by the molecular targets as follows: estrogen receptor assays (panel A), PPAR assays (panel B), PXR assays (panel C), aromatase assays (panel D), enzyme assays (panel E), and other (panel F)

Compiled by the Working Group

## 4.4 Organ toxicity

### 4.4.1 Mammary gland

#### (a) Humans

No studies of toxicological effects relevant to carcinogenicity in the breast/mammary gland after exposure to PFOA in humans were available to the Working Group.

#### (b) Experimental animals

Two studies in experimental animals reported effects on the mammary gland after exposure to PFOA. Pre-pubertal C57BL/6 or BALB/c mice (age, 21 days) were exposed to PFOA at a dose of 1, 5, or 10 mg/kg bw by gavage once daily, 5 days per week, for 4 weeks (Yang et al., 2009b). PFOA inhibited mammary-gland development in BALB/c mice. In C57BL/6 mice, PFOA inhibited mammary-gland development at 10 mg/kg bw, and stimulated mammary-gland development at 5 mg/kg bw. PFOA increased numbers of terminal end buds and stimulated/enlarged terminal ducts, which is indicative of mammary epithelial-cell proliferation. In another study, female CD-1 mice given PFOA at a dose of 0, 0.01, 0.1, or 1 mg/kg bw for 3 days starting on postnatal day 18, showed an increased weight of the uterus at the lowest dose of PFOA, suggesting an estrogenic effect (Dixon et al., 2012).

### 4.4.2 Nephrotoxicity

#### (a) Humans

Several studies in humans have reported mixed results regarding serum concentrations of PFOA and serum markers of kidney damage. In a cross-sectional study of adults from a community in which the drinking-water was contaminated with PFOA from a chemical plant, higher serum concentrations of PFOA were associated with higher serum concentrations of uric acid, but the limits of the study prohibited conclusions of causality (Steenland

et al., 2010). Two studies included in a review by Steenland et al. (2010) reported no significant association between exposure to PFOA and either urea nitrogen or creatinine in occupationally exposed subjects (Emmett et al., 2006; Costa et al., 2009). Using data from the National Health and Nutrition Examination Survey (NHANES), Shankar et al. (2011a, b) reported that elevated levels of serum uric acid and incidence of chronic kidney disease, defined as low glomerular filtration rate, were associated with increases in serum PFOA. Additional evaluations of data concerning associations between PFOA and the glomerular filtration rate in adolescents and children suggested that increases in serum PFOA may result from decreases in glomerular filtration rate rather than the opposite (Watkins et al., 2013).

#### (b) Experimental animals

One study in experimental animals reported kidney toxicity after exposure to PFOA. Male Sprague-Dawley rats given PFOA at a dose of 5 or 20 mg/kg bw by gavage for 28 days had signs of turbidity and tumefaction in the epithelia of the proximal convoluted tubule, including mild symptoms of congestion in the renal cortex and medulla, and enhanced cytoplasmic acidophilia (Cui et al., 2009).

### 4.4.3 Hepatotoxicity

#### (a) Humans

Several studies in humans have reported associations between serum concentrations of PFOA and serum markers of liver enzyme concentrations, which can be indicative of hepatocellular damage. Several such studies were included in a review by Steenland et al. (2010), and while they have reported some associations of changes to liver enzymes with serum PFOA concentrations (Emmett et al., 2006; Olsen & Zobel, 2007; Sakr et al., 2007; Costa et al., 2009; Lin et al., 2010), the changes in liver enzymes

were small, and the clinical significance of the reported changes was uncertain ([Steenland et al., 2010](#)). A more recent cross-sectional study of adults from a community in which drinking-water was contaminated with PFOA from a chemical plant also reported mild increases in serum PFOA and one liver enzyme ([Gallo et al., 2012](#)).

(b) *Experimental animals*

(i) *Non-human primates*

Male cynomolgus monkeys were given daily oral doses of ammonium perfluorooctanoate at 0, 3, 10, or 20 mg/kg bw per day for 26 weeks ([Butenhoff et al., 2002](#)). Histopathological evidence of liver injury was not observed in animals at 3 or 10 mg/kg bw; one moribund animal from the group at 20 mg/kg bw was killed on day 29, and was found to have mid-zonal and centrilobular hepatocellular degeneration and necrosis, diffuse hepatocellular vacuolation, and hepatocyte basophilia.

(ii) *Rats*

Several studies reported histopathology in the livers of rats exposed to PFOA either in the long-term, short-term, or as a single dose. In a long-term dietary study, male and female Sprague-Dawley rats were fed diets containing ammonium perfluorooctanoate at 1.5 or 15 mg/kg for 2 years ([Butenhoff et al., 2012b](#)). After 1 year of exposure, histopathology was confined to the liver; male rats at 15 mg/kg had focal hepatocellular necrosis, portal mononuclear cell infiltration, and increased cytoplasmic volume in parenchymal cells. The cytoplasm had a finely granular appearance. Male and female rats at unscheduled or terminal necropsy also showed signs of non-neoplastic effects in the liver, including cystoid degeneration, portal mononuclear cell infiltration, and hepatocellular necrosis.

Similarly, the livers of male Sprague-Dawley rats given PFOA at a dose of 5 or 20 mg/kg bw by

gavage for 28 days exhibited cytoplasmic vacuolation, focal or flakelike necrosis, fatty degeneration, angiectasis and congestion in the hepatic sinusoid or central vein, and acidophil lesion ([Cui et al., 2009](#)). Changes observed in livers of male Sprague-Dawley rats fed diet containing ammonium perfluorooctanoate at 15 mg/kg for 1, 7, or 28 days included hepatocellular hyperplasia, glycogen loss, and fatty vacuolation ([Elcombe et al., 2010](#)).

(iii) *Mice*

In male ICR mice exposed to drinking-water containing PFOA at a concentration of 0, 2, 10, 50, or 250 mg/L for 21 days, hepatic acidophilic cytoplasm was reported in the group with the highest exposure ([Son et al., 2008](#)). Both wild-type (129S4/SvImJ) and PPAR $\alpha$  null mice given PFOA at a dose of 0, 12.5, 25, or 50  $\mu$ mol/kg per day by gavage for 4 weeks had numerous histological changes in the liver, including reduction in glycogen granules, degranulation and disruption of the rough endoplasmic reticulum, and increased numbers of mitochondria ([Minata et al., 2010](#)).

(c) *Other experimental systems*

Human hepatoblastoma HepG2 cells incubated with PFOA at 0–550  $\mu$ M for 24 hours exhibited a dose-dependent increase in the frequency of apoptosis, starting at 200  $\mu$ M. With PFOA at higher doses (400 and 500  $\mu$ M), cells underwent primary and secondary necrosis ([Shabalina et al., 1999](#)). [The Working Group noted that these data were indicative of an antiproliferative response.] Additionally, a study with an ammonium salt of PFOA known as CXR1002 demonstrated that in various cell lines, CXR1002 could inhibit a protein kinase (PIM) that is anti-apoptotic when activated ([Barnett et al., 2010](#)). The antiproliferative effects of PFOA are the subject of a patent application for CSR1002 as an antineoplastic drug ([Elcombe et al., 2013](#)).

#### 4.4.4 Male reproductive organs

##### (a) Humans

No studies of toxicological effects relevant to testicular/Leydig cell carcinogenicity after exposure to PFOA in humans were available to the Working Group.

##### (b) Experimental animals

Two studies in experimental animals reported toxicological effects on male reproductive organs after exposure to PFOA. In a 2-year study in which male CD rats were fed diets containing PFOA at 0 or 300 ppm, or Wy 14 643 (a known PPAR $\alpha$  agonist) at 50 ppm, ad libitum, absolute testis weight was increased by exposure to PFOA or to Wy 14 643 at 24 months. No consistent changes were observed in the weights of epididymides or accessory sex organs (Biegel et al., 2001). Cook et al. (1992) reported that unit weight of accessory sex organs (combined ventral and dorsal lateral prostate, seminal vesicles, and coagulating glands) was decreased in CD rats exposed to ammonium perfluorooctanoate at 25 or 50 mg/kg bw by gavage for 14 days. Two separate studies in CD rats given ammonium perfluorooctanoate orally for 14 days or up to 2 years reported no changes in weight of the prostate gland (Cook et al., 1992; Biegel et al., 2001).

#### 4.4.5 Thyroid gland

##### (a) Humans

A limited number of epidemiological studies in humans have evaluated thyroid hormone concentrations, thyroid gland function, and thyroid disease associated with exposure to PFOA. A large-scale study of children aged 1–17 years from a highly exposed population in the mid-Ohio Valley, USA, reported that increases in serum PFOA concentrations were correlated with increases in hypothyroidism, but that neither serum total T4, nor thyroid-stimulating hormone were associated with serum PFOA

concentrations (Lopez-Espinosa et al., 2012). In an evaluation of adults from this mid-Ohio Valley population, increases in serum PFOA concentrations were associated with increases in serum T4 and a reduction in triiodotyrosine (T3) uptake (Knox et al., 2011). Winquist & Steenland (2014) examined the association between PFOA and thyroid disease among community members and workers of a chemical plant in mid-Ohio River valley. Associations were observed for hyperthyroidism and hypothyroidism among women. Some subanalyses also suggested increased hypothyroidism among men (Winquist & Steenland, 2014). Finally, in evaluations of data from NHANES, Melzer et al. (2010) reported that self-reported incidence of current thyroid disease (not specified) increased with serum PFOA concentrations, and Wen et al. (2013) reported increases in serum T4 and T3 levels with increases in serum PFOA.

##### (b) Experimental animals

###### (i) Non-human primates

Male cynomolgus monkeys were given daily oral doses of ammonium perfluorooctanoate at 0, 3, 10, or 20 mg/kg bw per day for 26 weeks (Butenhoff et al., 2002). At the end of the dosing period, decreases in levels of free and total T3 and T4 were noted in monkeys in the group receiving the highest dose. Additionally, monkeys from the groups at 3 and 10 mg/kg bw had increases in levels of thyroid-stimulating hormone, and decreases in total T4.

###### (ii) Rats

Male Sprague-Dawley rats given PFOA at a dose of 30 mg/kg bw by gavage for 28 days showed reductions in levels of serum thyroid-stimulating hormone, total T4, and free T4 (Butenhoff et al., 2012c). Similarly exposed female Sprague-Dawley rats had normal levels of serum thyroid-stimulating hormone, but reductions in serum total and free T4. After a 3-week recovery period, all levels returned to those of the controls, except



for levels of serum total and free T4 in males ([Butenhoff et al., 2012c](#)).

#### 4.4.6 Development

[Abbott et al. \(2007\)](#) found that PPAR $\alpha$  was required, in part, for certain developmental effects induced by PFOA in the mouse. Postnatal lethality and delays in development occurred in similarly exposed 129S1/SvImJ wild-type mice, but not in PPAR $\alpha$  null mice exposed to PFOA from day 1 of gestation until day 17. In CD-1 mice exposed to PFOA day 1 of gestation until day 17, patterns of PPAR $\alpha$  expression from gestation until age 28 days were tissue-specific and, in the liver, correlated with nutritional changes as the offspring matured ([Abbott et al., 2012](#)). As early as day 14 of gestation, exposure to PFOA affected PPAR $\alpha$  and related genes associated with fatty acid biosynthesis,  $\beta$ -oxidation, and glucose metabolism, suggesting a role for these genes in poor postnatal survival and growth. An additional study by [Albrecht et al. \(2013\)](#), using the same exposure protocol, but in wild-type, PPAR $\alpha$ -null, and human PPAR $\alpha$ -transgenic mice, demonstrated that while human PPAR $\alpha$ -transgenic mice had increases in hepatic markers of PPAR $\alpha$  activation at day 18 of gestation, no effect was seen at postnatal day 20. Unlike wild-type mice, postnatal survival in human PPAR $\alpha$ -transgenic mice was unaffected by exposure to PFOA, suggesting reduced sensitivity in mice expressing human PPAR $\alpha$ .

#### 4.4.7 Other target organs

No studies on the toxicological effects of exposure to PFOA in the bladder and pancreas were available to the Working Group. Several studies examined the effects of PFOA on the immune system.

Intraperitoneal administration of PFOA in male Sprague-Dawley rats inhibited induced oedema and thermal hypersensitivity in a

dose-dependent manner ([Taylor et al., 2002](#)). Subsequent studies indicated that the anti-inflammatory properties of PFOA were not mediated through the release of endogenous glucocorticoids ([Taylor et al., 2005](#)), but possibly involved binding to the retinoid X receptor (RXR)  $\alpha$  ([Wan & Badr, 2006](#)). Microarray analyses of liver from Sprague-Dawley rats treated with PFOA indicated anti-inflammatory properties of PFOA at the mRNA level, with the observation of reduced expression of genes regulating inflammatory mediators ([Guruge et al., 2006](#)). [The Working Group noted that studies evaluating cytokine responses after exposure to PFOA (Section 4.3.7) indicated that PFOA can be proinflammatory.]

## 4.5 Susceptible populations

### 4.5.1 Polymorphisms

PFOA is not metabolized in humans or other mammalian organisms ([Lau, 2012](#); [Post et al., 2012](#)); thus it is unlikely that known genetic polymorphisms in xenobiotic metabolism genes that have been associated with genetic susceptibility to other toxicants would have relevance to PFOA as a human health hazard. It is clear, however, that species- and sex-specific differences in renal clearance of PFOA are largely attributable to the function of renal transporters. Depending on species and sex, excretion and reabsorption transporters were implicated as major determinants of the rate of elimination of PFOA ([Han et al., 2012](#)). Specifically, OAT4 and URAT1 were identified as transporters that are most likely to be responsible for efficient renal tubular reabsorption of perfluorinated compounds, including PFOA, due to their localization in the apical membrane of the proximal tubular cells in human kidney ([Han et al., 2012](#)).

No study has examined the role of transporter polymorphisms in PFOA-dependent effects in humans. However, several studies examined polymorphisms in OAT4 and URAT1.

Non-synonymous single nucleotide polymorphisms were reported that result in amino acid differences in OAT4 ([Xu et al., 2005](#)).

Functional URAT1 polymorphisms and transcription factor-dependent differences in expression have been reported. Loss-of-function mutations of URAT1 are the cause of familial idiopathic renal hypouricaemia ([Enomoto & Endou 2005](#)). Additional polymorphisms were detected in patients with renal hypouricaemia that were either silent or led to reduced urate transport ([Burckhardt, 2012](#)). HNF-1 $\alpha$  and HNF-1 $\beta$  increase the promoter expression of human and mouse URAT1, and HNF-1 $\alpha$ -deficient mice showed diminished expression of Urat1 in the kidney ([Kikuchi et al., 2007](#)). In addition, promoter methylation status is important for tissue-specific URAT1 expression ([Kikuchi et al., 2007](#)).

In a study of immortalized human lymphoblast cell lines from the Centre d'Etude du Polymorphisme Humain (CEPH) trios assembled by the HapMap Consortium, exposure to PFOA was shown to elicit the greatest degree of interindividual variability in cytotoxicity and induction of apoptosis ([O'Shea et al., 2011](#)). Notably, responses to PFOA and phenobarbital were highly correlated across the population of cell lines tested in the cytotoxicity assay. The genome-wide analysis showed suggestive evidence ( $P < 10^{-6}$ ) for the loci on chromosomes 4 and 14. Within loci spanning 500 kb and flanking single nucleotide polymorphisms with highest association, there were several potential candidate genes associated with susceptibility to PFOA ([O'Shea et al., 2011](#)). On chromosome 4, FAT tumour suppressor homologue 1 (FAT1) is a human gene whose rat homologue has been shown to be responsive to PFOA treatment (in the liver) ([Guruge et al., 2006](#); [O'Shea et al., 2011](#)). On chromosome 14, three genes were located in the candidate quantitative trait locus: solute carrier family 24 member 4 (SLC24A4); cleavage and polyadenylation specific factor 2 (CPSF2);

and Ras and Rab interactor 3 (RIN3). SLC24A4 is a sodium/potassium/calcium exchange protein that is highly expressed in the kidneys. Although CPSF2 and RIN3 have not been shown in previous studies to be responsive to treatment with PFOA, they are tightly linked through a gene network to genes that have been observed as responsive to PFOA treatment in other species. Networks for CPSF2 and RIN3 showed the interactions with immunoglobulin heavy constant mu and RAB5A/B, member of RAS oncogene family (RAB5A and RAB5B), respectively, which are responsive to PFOA in rat and chicken liver ([Guruge et al., 2006](#); [Yeung et al., 2007](#)).

#### 4.5.2 Lifestage

As discussed in Section 4.4.6, several studies examined the effects of exposure to PFOA in early life. However, none of these studies evaluated the effects of these exposures on tumour production or carcinogenesis in adult animals, or compared different exposure periods to determine whether susceptibility to toxic events in later life was increased when exposure occurs early in life.

## 4.6 Mechanistic considerations

The toxicokinetics of PFOA are well established in animals and humans. PFOA is not metabolized in humans or experimental animals ([D'eon & Mabury, 2011](#)). Sex-specific differences in plasma half-life have been observed in rats ([Kemper & Jepson, 2003](#)). It is also evident that the plasma half-life in humans is much longer than in any experimental animal studied ([Butenhoff et al., 2002, 2004](#); [Noker, 2003](#); [Hundley et al., 2006](#); [Olsen et al., 2007](#); [Bartell et al., 2010](#)). These differences in half-lives were attributed to differences in renal reabsorption of PFOA ([Han et al., 2012](#)). While there are no direct data on genetic susceptibility, renal transporters that are involved in reabsorption of PFOA are polymorphic in

human populations, suggesting the potential for genetic susceptibility.

It is widely accepted that PFOA is not directly genotoxic. Associations between PFOA-induced oxidative stress and DNA damage or mutation have been reported in some studies ([Yao & Zhong, 2005](#); [Fernández Freire et al., 2008](#); [Zhao et al., 2011](#)), but not in others ([Florentin et al., 2011](#)). Overall, the role of PFOA-related oxidative stress in carcinogenicity remains unclear.

A wide array of experimental studies in animals and in vitro have been conducted with PFOA and show adverse health effects. Several potential mechanistic events have been identified as possible drivers of PFOA toxicity in multiple tissues. These include, but are not limited to, nuclear receptor activation, cytotoxicity, oxidative stress, alteration of inflammatory pathways, and alterations in hormone levels.

The liver is the most prominent target tissue of PFOA, with rats and mice being the most responsive species to liver-specific effects. Limited data are available indicating liver toxicity in non-human primates ([Butenhoff et al., 2002](#)). Additionally, serum levels of PFOA have been positively associated with serum markers of liver injury in humans ([Sakr et al., 2007](#); [Lin et al., 2010](#); [Gallo et al., 2012](#)). Liver toxicity observed in rodents has been associated with both PPAR $\alpha$ -dependent and -independent mechanisms. The analysis by the Working Group of data from humans in vitro is consistent with multiple molecular pathways being in operation. Cytotoxicity, cell proliferation, and liver hypertrophy have also been observed in studies with PFOA in rodents, indicating that other mechanisms may also contribute.

PFOA modulates inflammatory pathways, such as those involving the production of cytokines. Additionally, PFOA alters hormone levels and activates hormone receptors. Changes in levels of thyroid hormones have been observed in rodents ([Butenhoff et al., 2012b](#)) and in non-human primates ([Butenhoff et al., 2002](#)).

In studies in humans, PFOA increased levels of serum thyroid hormones ([Knox et al., 2011](#); [Lopez-Espinosa et al., 2012](#); [Wen et al., 2013](#)). In human cells in vitro, and in fish in vivo and in vitro, PFOA activated estrogen receptors (ToxCast research programme, see Section 4.3.8) ([Maras et al., 2006](#); [Liu et al., 2007b](#); [Wei et al., 2007, 2008](#); [Tilton et al., 2008](#); [Benninghoff et al., 2011, 2012](#); [Henry & Fair, 2013](#)). In rodents, PFOA altered female reproductive hormones and tissues ([Yang et al., 2009b](#); [Zhao et al., 2010c](#)), disrupted the estradiol/testosterone balance, and induced aromatase activity ([Cook et al., 1992](#); [Biegel et al., 1995, 2001](#)). Prenatal and early-life exposures to PFOA also affect mammary-gland development in rodents. However, the importance of PFOA-induced modulation of the immune system or hormone levels in carcinogenesis is uncertain.

## 5. Summary of Data Reported

### 5.1 Exposure data

Perfluorooctanoic acid (PFOA) is a synthetic fluorinated carboxylic acid. There are two production methods: the electrochemical fluorination process results in a mixture of branched and straight-chain isomers of the ammonium salt, while the telomerization process, a method in use since the early 2000s, results in an isomerically pure, straight-chain product. PFOA and its salts have been mainly used as emulsifiers in the production of fluoropolymers such as polytetrafluoroethylene. PFOA has been used in metal cleaners, electrolytic-plating baths, self-shine floor polishes, cement, fire-fighting formulations, varnishes, emulsion polymerization, lubricants, gasoline, leather, and textile treatments and as non-stick coatings on cookware and in paper coatings such as food packaging. PFOA is persistent in the environment and has been detected in air, water, dust, and food. For most of the general population, the predominant sources of exposure

are food (including transfer of PFOA from food packaging) and dust. Serum concentrations of perfluorooctanoate of less than about 10 µg/L have been measured in the general population worldwide; serum concentrations increased over time until about 2000, and have since remained constant or decreased. In people living near industrial sources of perfluorooctanoate, mean serum concentrations have ranged from near-background concentrations to > 200 µg/L. In these groups, the predominant route of exposure was drinking-water. Occupational exposure, through inhalation and dermal contact, occurs during fluoropolymer production using PFOA, and mean serum concentrations in groups of workers with the highest exposure were measured as > 1000 µg/L.

## 5.2 Human carcinogenicity data

The literature on the epidemiology of cancer in relation to PFOA is relatively small and includes studies in three different types of populations: workers exposed in chemical plants producing or using PFOA, high-exposure communities (i.e. areas surrounding a plant with documented release of PFOA and contamination of public and private water supplies), and studies in the general population with background exposures.

### 5.2.1 *Cancer of the testis*

The only informative results on risk of cancer of the testis were from two studies of cancer incidence in a high-exposure community setting in West Virginia and Ohio, USA; there was some overlap in the cases examined in these studies. Both publications, using different study designs (i.e. a cohort study of incidence and a population-registry case-control study), observed an increased risk of incidence of cancer of the testis. In the highest quartile of exposure in both studies, the observed increase in risk was approximately threefold, with a significant trend in increasing

risk with increasing exposure in the cohort study (no trend test was reported in the case-control study). The evidence for cancer of the testis was considered credible and unlikely to be explained by bias and confounding, however, the estimate was based on small numbers.

### 5.2.2 *Cancer of the kidney*

There were several publications that have examined PFOA and risk of cancer of the kidney. Three of these were conducted in West Virginia, USA, and included occupational and community exposure, and the fourth was conducted in a different occupational setting. In the exposure-response analysis of workers in West Virginia, 8 of the 12 deaths from cancer of the kidney were seen in the highest quartile of exposure, with an elevated standardized mortality ratio and a significant trend in increasing risk with increasing exposure. The other occupational cohort study reported no evidence for increased incidence. A modestly increased risk of incidence of cancer of the kidney was seen in a community population with high exposure. A study in a somewhat overlapping population also found elevated relative risks in the groups with high and very high exposure compared with the group with low exposure. The evidence for cancer of the kidney was considered credible; however, chance, bias, and confounding could not be ruled out with reasonable confidence.

### 5.2.3 *Other cancer sites*

The evidence regarding other cancer sites, including the urinary bladder, thyroid, prostate, liver, and pancreas was also evaluated. Some positive associations were observed for cancers of the bladder, thyroid, and prostate, but the results were inconsistent among studies and based on small numbers. The evidence for carcinogenicity for all of these sites was judged to be inadequate.

### 5.3 Animal carcinogenicity data

PFOA was administered in the feed in one study of carcinogenicity in male and female rats, and in another study in male rats. PFOA increased the incidence of testicular Leydig cell adenoma in males in both studies, and increased the incidences of hepatocellular adenoma and pancreatic acinar cell adenoma in the study in male rats only.

PFOA was also shown to promote hepatocarcinogenesis in two feeding studies in male rats and two feeding studies in rainbow trout.

### 5.4 Mechanistic and other relevant data

PFOA does not undergo metabolism in the experimental systems studied or in humans. It is readily absorbed via all routes of exposure and is excreted into the urine. Among the species studied, humans are unique in that the reabsorption of PFOA in the kidneys is highly efficient, leading to much longer retention in the body when compared with all other animals. Therefore, the body burden of PFOA experienced by humans is much greater than in experimental animals.

PFOA is not DNA-reactive, and gives negative results in an overwhelming number of assays for direct genotoxicity. Therefore, there is *strong* evidence that direct genotoxicity is not a mechanism of PFOA carcinogenesis. Some studies with PFOA indicate that indirect DNA damage may result from induction of oxidative stress, therefore there is *moderate* evidence that genotoxicity overall is not a mechanism of PFOA carcinogenesis.

Several studies in humans have examined the relationship between exposure to PFOA and toxicity, and suggest that PFOA may cause liver injury. In experimental animals, the liver is a well-established target for toxicity. Potential mechanisms for PFOA-induced toxicity and

carcinogenicity in the liver include PPAR $\alpha$  activation, involvement of other molecular pathways (i.e. constitutive androstane receptor, pregnane X receptor, estrogen receptor), and cytotoxicity. There is *moderate* evidence for these mechanisms, largely from studies in rats and mice. Based on the available evidence, human relevance of the liver findings in rodents cannot be excluded.

The effects of PFOA in other organs are not so well established, but modulation of inflammatory pathways and hormone levels has been reported. Studies in human cells, rodents, and fish, have documented perturbation of molecular pathways involving reproductive hormones and hormone receptors, such as activation of estrogen receptor, interference with testosterone/estradiol balance, and induction of aromatase, and effects on reproductive organs consistent with estrogenicity. Although there is *moderate* evidence that PFOA affects reproductive-hormone pathways, there is *weak* evidence for their relevance to PFOA-associated carcinogenesis.

Overall, there is *moderate* evidence for mechanisms of PFOA-associated carcinogenesis, including some evidence for these mechanisms being operative in humans.

## 6. Evaluation

### 6.1 Cancer in humans

There is *limited evidence* in humans for the carcinogenicity of perfluorooctanoic acid (PFOA). A positive association was observed for cancers of the testis and kidney.

### 6.2 Cancer in experimental animals

There is *limited evidence* in experimental animals for the carcinogenicity of perfluorooctanoic acid (PFOA).

### 6.3 Overall evaluation

Perfluorooctanoic acid (PFOA) is *possibly carcinogenic to humans (Group 2B)*.

### References

- Abbott BD, Wolf CJ, Schmid JE, Das KP, Zehr RD, Helfant L, et al. (2007). Perfluorooctanoic acid induced developmental toxicity in the mouse is dependent on expression of peroxisome proliferator activated receptor-alpha. *Toxicol Sci*, 98(2):571–81. doi:[10.1093/toxsci/kfm110](https://doi.org/10.1093/toxsci/kfm110) PMID:[17488742](https://pubmed.ncbi.nlm.nih.gov/17488742/)
- Abbott BD, Wood CR, Watkins AM, Tatum-Gibbs K, Das KP, Lau C (2012). Effects of perfluorooctanoic acid (PFOA) on expression of peroxisome proliferator-activated receptors (PPAR) and nuclear receptor-regulated genes in fetal and postnatal CD-1 mouse tissues. *Reprod Toxicol*, 33(4):491–505. doi:[10.1016/j.reprotox.2011.11.005](https://doi.org/10.1016/j.reprotox.2011.11.005) PMID:[22154759](https://pubmed.ncbi.nlm.nih.gov/22154759/)
- Abdellatif A, Al-Tonsy AH, Awad ME, Roberfroid M, Khan MN (2003). Peroxisomal enzymes and 8-hydroxydeoxyguanosine in rat liver treated with perfluorooctanoic acid. *Dis Markers*, 19(1):19–25. doi:[10.1155/2003/135859](https://doi.org/10.1155/2003/135859) PMID:[14757943](https://pubmed.ncbi.nlm.nih.gov/14757943/)
- Abdellatif AG, Pr at V, Taper HS, Roberfroid M (1991). The modulation of rat liver carcinogenesis by perfluorooctanoic acid, a peroxisome proliferator. *Toxicol Appl Pharmacol*, 111(3):530–7. doi:[10.1016/0041-008X\(91\)90257-F](https://doi.org/10.1016/0041-008X(91)90257-F) PMID:[1684073](https://pubmed.ncbi.nlm.nih.gov/1684073/)
- Abdellatif AG, Pr at V, Vamecq J, Nilsson R, Roberfroid M (1990). Peroxisome proliferation and modulation of rat liver carcinogenesis by 2,4-dichlorophenoxyacetic acid, 2,4,5-trichlorophenoxyacetic acid, perfluorooctanoic acid and nafenopin. *Carcinogenesis*, 11(11):1899–902. doi:[10.1093/carcin/11.11.1899](https://doi.org/10.1093/carcin/11.11.1899) PMID:[2225320](https://pubmed.ncbi.nlm.nih.gov/2225320/)
- Albrecht PP, Torsell NE, Krishnan P, Ehresman DJ, Frame SR, Chang SC, et al. (2013). A species difference in the peroxisome proliferator-activated receptor alpha-dependent response to the developmental effects of perfluorooctanoic acid. *Toxicol Sci*, 131(2):568–82. doi:[10.1093/toxsci/kfs318](https://doi.org/10.1093/toxsci/kfs318)
- Alexander BH, Olsen GW (2007). Bladder cancer in perfluorooctanesulfonyl fluoride manufacturing workers. *Ann Epidemiol*, 17(6):471–8. doi:[10.1016/j.annepidem.2007.01.036](https://doi.org/10.1016/j.annepidem.2007.01.036) PMID:[17448680](https://pubmed.ncbi.nlm.nih.gov/17448680/)
- Alexander BH, Olsen GW, Burris JM, Mandel JH, Mandel JS (2003). Mortality of employees of a perfluorooctanesulfonyl fluoride manufacturing facility. *Occup Environ Med*, 60(10):722–9. doi:[10.1136/oem.60.10.722](https://doi.org/10.1136/oem.60.10.722) PMID:[14504359](https://pubmed.ncbi.nlm.nih.gov/14504359/)
- Apelberg BJ, Goldman LR, Calafat AM, Herbstman JB, Kuklennyik Z, Heidler J, et al. (2007a). Determinants of Fetal Exposure to Polyfluoroalkyl Compounds in Baltimore, Maryland. *Environ Sci Technol*, 41(11):3891–7. doi:[10.1021/es0700911](https://doi.org/10.1021/es0700911)
- Apelberg BJ, Witter FR, Herbstman JB, Calafat AM, Halden RU, Needham LL, et al. (2007b). Cord serum concentrations of perfluorooctanesulfonate (PFOS) and perfluorooctanoate (PFOA) in relation to weight and size at birth. *Environ Health Perspect*, 115(11):1670–6. doi:[10.1289/ehp.10334](https://doi.org/10.1289/ehp.10334) PMID:[18008002](https://pubmed.ncbi.nlm.nih.gov/18008002/)
- Arbuckle TE, Kubwabo C, Walker M, Davis K, Lalonde K, Kosarac I, et al. (2013). Umbilical cord blood levels of perfluoroalkyl acids and polybrominated flame retardants. *Int J Hyg Environ Health*, 216(2):184–94. doi:[10.1016/j.ijheh.2012.03.004](https://doi.org/10.1016/j.ijheh.2012.03.004) PMID:[22494936](https://pubmed.ncbi.nlm.nih.gov/22494936/)
- ATSDR (2009). Draft. Toxicological profile for perfluoroalkyls. Atlanta: United States Department of Health And Human Services, Public Health Service, Agency for Toxic Substances and Disease Registry. Available from: <http://www.atsdr.cdc.gov/ToxProfiles/tp200.pdf>, accessed 15 September 2014.
- Attene-Ramos MS, Miller N, Huang R, Michael S, Itkin M, Kavlock RJ, et al. (2013). The Tox21 robotic platform for the assessment of environmental chemicals—from vision to reality. *Drug Discov Today*, 18(15–16):716–23. doi:[10.1016/j.drudis.2013.05.015](https://doi.org/10.1016/j.drudis.2013.05.015) PMID:[23732176](https://pubmed.ncbi.nlm.nih.gov/23732176/)
- Badr MZ, Birnbaum LS (2004). Enhanced potential for oxidative stress in livers of senescent rats by the peroxisome proliferator-activated receptor alpha agonist perfluorooctanoic acid. *Mech Ageing Dev*, 125(1):69–75. doi:[10.1016/j.mad.2003.10.006](https://doi.org/10.1016/j.mad.2003.10.006) PMID:[14706239](https://pubmed.ncbi.nlm.nih.gov/14706239/)
- Barber JL, Berger U, Chaemfa C, Huber S, Jahnke A, Temme C, et al. (2007). Analysis of per- and polyfluorinated alkyl substances in air samples from Northwest Europe. *J Environ Monit*, 9(6):530–41. doi:[10.1039/b701417a](https://doi.org/10.1039/b701417a) PMID:[17554424](https://pubmed.ncbi.nlm.nih.gov/17554424/)
- Barnett A, Ding S, Murray C, Chamberlain M, Plummer S, Evans TRJ, et al. (2010). 123 Anti-tumor activity of CXR1002, a novel anti-cancer clinical phase compound that induces ER stress and inhibits PIM kinases: Human tumor xenograft efficacy and in vitro mode of action. *Eur J Cancer*, Suppl 8(7):45–6. doi:[10.1016/S1359-6349\(10\)71828-0](https://doi.org/10.1016/S1359-6349(10)71828-0)
- Barry V, Winquist A, Steenland K (2013). Perfluorooctanoic acid (PFOA) exposures and incident cancers among adults living near a chemical plant. *Environ Health Perspect*, 121(11-12):1313–8. PMID:[24007715](https://pubmed.ncbi.nlm.nih.gov/24007715/)
- Bartell SM, Calafat AM, Lyu C, Kato K, Ryan PB, Steenland K (2010). Rate of decline in serum PFOA concentrations after granular activated carbon filtration at two public water systems in Ohio and West Virginia. *Environ Health Perspect*, 118(2):222–8. doi:[10.1289/ehp.0901252](https://doi.org/10.1289/ehp.0901252) PMID:[20123620](https://pubmed.ncbi.nlm.nih.gov/20123620/)
- Benninghoff AD, Bisson WH, Koch DC, Ehresman DJ, Kolluri SK, Williams DE (2011). Estrogen-like activity of perfluoroalkyl acids in vivo and interaction with human and rainbow trout estrogen receptors in vitro.

- Toxicol Sci*, 120(1):42–58. doi:[10.1093/toxsci/kfq379](https://doi.org/10.1093/toxsci/kfq379) PMID:[21163906](https://pubmed.ncbi.nlm.nih.gov/21163906/)
- Benninghoff AD, Orner GA, Buchner CH, Hendricks JD, Duffy AM, Williams DE (2012). Promotion of hepatocarcinogenesis by perfluoroalkyl acids in rainbow trout. *Toxicol Sci*, 125(1):69–78. doi:[10.1093/toxsci/kfr267](https://doi.org/10.1093/toxsci/kfr267) PMID:[21984479](https://pubmed.ncbi.nlm.nih.gov/21984479/)
- Benskin JP, De Silva AO, Martin JW (2010). Isomer profiling of perfluorinated substances as a tool for source tracking: a review of early findings and future applications. In: Voogt P, Whitacre DM, editors. *Reviews of environmental contamination and toxicology: Volume 208. Perfluorinated alkylated substances*. New York: Springer; pp. 111–160.
- Berger U, Haukås M (2005). Validation of a screening method based on liquid chromatography coupled to high-resolution mass spectrometry for analysis of perfluoroalkylated substances in biota. *J Chromatogr A*, 1081(2):210–7. doi:[10.1016/j.chroma.2005.05.064](https://doi.org/10.1016/j.chroma.2005.05.064) PMID:[16038211](https://pubmed.ncbi.nlm.nih.gov/16038211/)
- Bernsmann T, Fürst P (2008). Determination of perfluorinated compounds in human milk. *Organohalogen Compd*, 70:718–21.
- Biegel LB, Hurtt ME, Frame SR, O'Connor JC, Cook JC (2001). Mechanisms of extrahepatic tumor induction by peroxisome proliferators in male CD rats. *Toxicol Sci*, 60(1):44–55. doi:[10.1093/toxsci/60.1.44](https://doi.org/10.1093/toxsci/60.1.44) PMID:[11222872](https://pubmed.ncbi.nlm.nih.gov/11222872/)
- Biegel LB, Liu RC, Hurtt ME, Cook JC (1995). Effects of ammonium perfluorooctanoate on Leydig cell function: in vitro, in vivo, and ex vivo studies. *Toxicol Appl Pharmacol*, 134(1):18–25. doi:[10.1006/taap.1995.1164](https://doi.org/10.1006/taap.1995.1164) PMID:[7676454](https://pubmed.ncbi.nlm.nih.gov/7676454/)
- Bjork JA, Butenhoff JL, Wallace KB (2011). Multiplicity of nuclear receptor activation by PFOA and PFOS in primary human and rodent hepatocytes. *Toxicology*, 288(1–3):8–17. doi:[10.1016/j.tox.2011.06.012](https://doi.org/10.1016/j.tox.2011.06.012) PMID:[21723365](https://pubmed.ncbi.nlm.nih.gov/21723365/)
- Bjork JA, Wallace KB (2009). Structure-activity relationships and human relevance for perfluoroalkyl acid-induced transcriptional activation of peroxisome proliferation in liver cell cultures. *Toxicol Sci*, 111(1):89–99. doi:[10.1093/toxsci/kfp093](https://doi.org/10.1093/toxsci/kfp093) PMID:[19407336](https://pubmed.ncbi.nlm.nih.gov/19407336/)
- Bonefeld-Jorgensen EC, Long M, Bossi R, Ayotte P, Asmund G, Krüger T, et al. (2011). Perfluorinated compounds are related to breast cancer risk in Greenlandic Inuit: a case control study. *Environ Health*, 10(1):88. doi:[10.1186/1476-069X-10-88](https://doi.org/10.1186/1476-069X-10-88) PMID:[21978366](https://pubmed.ncbi.nlm.nih.gov/21978366/)
- Buck RC, Franklin J, Berger U, Conder JM, Cousins IT, de Voogt P, et al. (2011). Perfluoroalkyl and polyfluoroalkyl substances in the environment: terminology, classification, and origins. *Integr Environ Assess Manag*, 7(4):513–41. doi:[10.1002/ieam.258](https://doi.org/10.1002/ieam.258) PMID:[21793199](https://pubmed.ncbi.nlm.nih.gov/21793199/)
- Burckhardt G (2012). Drug transport by organic anion transporters (OATs). *Pharmacol Ther*, 136(1):106–30. doi:[10.1016/j.pharmthera.2012.07.010](https://doi.org/10.1016/j.pharmthera.2012.07.010) PMID:[22841915](https://pubmed.ncbi.nlm.nih.gov/22841915/)
- Butenhoff J, Costa G, Elcombe C, Farrar D, Hansen K, Iwai H, et al. (2002). Toxicity of ammonium perfluorooctanoate in male cynomolgus monkeys after oral dosing for 6 months. *Toxicol Sci*, 69(1):244–57. doi:[10.1093/toxsci/69.1.244](https://doi.org/10.1093/toxsci/69.1.244) PMID:[12215680](https://pubmed.ncbi.nlm.nih.gov/12215680/)
- Butenhoff JL, Bjork JA, Chang SC, Ehresman DJ, Parker GA, Das K, et al. (2012c). Toxicological evaluation of ammonium perfluorobutyrate in rats: twenty-eight-day and ninety-day oral gavage studies. *Reprod Toxicol*, 33(4):513–30. doi:[10.1016/j.reprotox.2011.08.004](https://doi.org/10.1016/j.reprotox.2011.08.004) PMID:[21878386](https://pubmed.ncbi.nlm.nih.gov/21878386/)
- Butenhoff JL, Kennedy GL Jr, Chang S-C, Olsen W (2012a). Chronic dietary toxicity and carcinogenicity study with ammonium perfluorooctanoate in Sprague-Dawley rats. *Toxicology*, 298(1–3):1–13. doi:[10.1016/j.tox.2012.04.001](https://doi.org/10.1016/j.tox.2012.04.001)
- Butenhoff JL, Kennedy GL Jr, Hinderliter PM, Lieder PH, Jung R, Hansen KJ, et al. (2004). Pharmacokinetics of perfluorooctanoate in cynomolgus monkeys. *Toxicol Sci*, 82(2):394–406. doi:[10.1093/toxsci/kfh302](https://doi.org/10.1093/toxsci/kfh302) PMID:[15470233](https://pubmed.ncbi.nlm.nih.gov/15470233/)
- Butenhoff JL, Pieterman E, Ehresman DJ, Gorman GS, Olsen GW, Chang SC, et al. (2012b). Distribution of perfluorooctanesulfonate and perfluorooctanoate into human plasma lipoprotein fractions. *Toxicol Lett*, 210(3):360–5. doi:[10.1016/j.toxlet.2012.02.013](https://doi.org/10.1016/j.toxlet.2012.02.013) PMID:[22387339](https://pubmed.ncbi.nlm.nih.gov/22387339/)
- Cai Y, Appelkvist EL, DePierre JW (1995). Hepatic oxidative stress and related defenses during treatment of mice with acetylsalicylic acid and other peroxisome proliferators. *J Biochem Toxicol*, 10(2):87–94. doi:[10.1002/jbt.2570100205](https://doi.org/10.1002/jbt.2570100205) PMID:[7562957](https://pubmed.ncbi.nlm.nih.gov/7562957/)
- Calafat AM, Kuklenyik Z, Reidy JA, Caudill SP, Tully JS, Needham LL (2007a). Serum concentrations of 11 polyfluoroalkyl compounds in the U.S. population: data from the national health and nutrition examination survey (NHANES) 1999–2000. *Environ Sci Technol*, 41(7):2237–42. doi:[10.1021/es062686m](https://doi.org/10.1021/es062686m) PMID:[17438769](https://pubmed.ncbi.nlm.nih.gov/17438769/)
- Calafat AM, Wong LY, Kuklenyik Z, Reidy JA, Needham LL (2007b). Polyfluoroalkyl chemicals in the U.S. population: data from the National Health and Nutrition Examination Survey (NHANES) 2003–2004 and comparisons with NHANES 1999–2000. *Environ Health Perspect*, 115(11):1596–602. doi:[10.1289/ehp.10598](https://doi.org/10.1289/ehp.10598) PMID:[18007991](https://pubmed.ncbi.nlm.nih.gov/18007991/)
- California Department of Public Health (2014). The California Environmental Contaminant Biomonitoring Program. Biomonitoring California, California Department of Public Health, Department of Toxic Substances Control, Office of Environmental Health Hazard Assessment. Available from: [http://www.biomonitoring.ca.gov/results/chemical/all?field\\_chemical\\_name\\_target\\_id\\_selective\[0\]=165](http://www.biomonitoring.ca.gov/results/chemical/all?field_chemical_name_target_id_selective[0]=165), accessed 4 September 2015.
- Caverly-Rae J, Frame S, Kennedy G, et al. (2014). Pathology review of proliferative lesions of the exocrine pancreas

- in two chronic feeding studies in rats with ammonium perfluorooctanoate. *Toxicol Rev*, 1:85–91.
- Chen MH, Ha EH, Wen TW, Su YN, Lien GW, Chen CY, et al. (2012). Perfluorinated compounds in umbilical cord blood and adverse birth outcomes. *PLoS ONE*, 7(8):e42474. doi:[10.1371/journal.pone.0042474](https://doi.org/10.1371/journal.pone.0042474) PMID:[22879996](https://pubmed.ncbi.nlm.nih.gov/22879996/)
- Consonni D, Straif K, Symons JM, et al. (2013). Cancer risk among tetrafluoroethylene synthesis and polymerization workers. *Am J Epidemiol*, 178:350–358. doi:[10.1093/aje/kws588](https://doi.org/10.1093/aje/kws588) PMID:[23828249](https://pubmed.ncbi.nlm.nih.gov/23828249/)
- Cook JC, Murray SM, Frame SR, Hurtt ME (1992). Induction of Leydig cell adenomas by ammonium perfluorooctanoate: a possible endocrine-related mechanism. *Toxicol Appl Pharmacol*, 113(2):209–17. doi:[10.1016/0041-008X\(92\)90116-A](https://doi.org/10.1016/0041-008X(92)90116-A) PMID:[1561629](https://pubmed.ncbi.nlm.nih.gov/1561629/)
- Corsini E, Avogadro A, Galbiati V, dell'Agli M, Marinovich M, Galli CL, et al. (2011). In vitro evaluation of the immunotoxic potential of perfluorinated compounds (PFCs). *Toxicol Appl Pharmacol*, 250(2):108–16. doi:[10.1016/j.taap.2010.11.004](https://doi.org/10.1016/j.taap.2010.11.004) PMID:[21075133](https://pubmed.ncbi.nlm.nih.gov/21075133/)
- Corsini E, Sangiovanni E, Avogadro A, Galbiati V, Viviani B, Marinovich M, et al. (2012). In vitro characterization of the immunotoxic potential of several perfluorinated compounds (PFCs). *Toxicol Appl Pharmacol*, 258(2):248–55. doi:[10.1016/j.taap.2011.11.004](https://doi.org/10.1016/j.taap.2011.11.004) PMID:[22119708](https://pubmed.ncbi.nlm.nih.gov/22119708/)
- Costa G, Sartori S, Consonni D (2009). Thirty years of medical surveillance in perfluorooctanoic acid production workers. *J Occup Environ Med*, 51(3):364–72. doi:[10.1097/JOM.0b013e3181965d80](https://doi.org/10.1097/JOM.0b013e3181965d80) PMID:[19225424](https://pubmed.ncbi.nlm.nih.gov/19225424/)
- Costner P, Thorpe B, McPherson A (2005). Sick of dust. Chemicals in common products – a needless health risk in our homes. Spring Brook, NY: Safer Products Project, Clean Production Action. Available from: [http://noharm.org/lib/downloads/electronics/Sick\\_of\\_Dust.pdf](http://noharm.org/lib/downloads/electronics/Sick_of_Dust.pdf).
- Cui L, Liao CY, Zhou QF, Xia TM, Yun ZJ, Jiang GB (2010). Excretion of PFOA and PFOS in male rats during a subchronic exposure. *Arch Environ Contam Toxicol*, 58(1):205–13. doi:[10.1007/s00244-009-9336-5](https://doi.org/10.1007/s00244-009-9336-5) PMID:[19468665](https://pubmed.ncbi.nlm.nih.gov/19468665/)
- Cui L, Zhou QF, Liao CY, Fu JJ, Jiang GB (2009). Studies on the toxicological effects of PFOA and PFOS on rats using histological observation and chemical analysis. *Arch Environ Contam Toxicol*, 56(2):338–49. doi:[10.1007/s00244-008-9194-6](https://doi.org/10.1007/s00244-008-9194-6) PMID:[18661093](https://pubmed.ncbi.nlm.nih.gov/18661093/)
- D'eon JC, Mabury SA (2011). Exploring indirect sources of human exposure to perfluoroalkyl carboxylates (PFCAs): evaluating uptake, elimination, and biotransformation of polyfluoroalkyl phosphate esters (PAPs) in the rat. *Environ Health Perspect*, 119(3):344–50. doi:[10.1289/ehp.1002409](https://doi.org/10.1289/ehp.1002409) PMID:[21059488](https://pubmed.ncbi.nlm.nih.gov/21059488/)
- De Silva AO, Allard CN, Spencer C, Webster GM, Shoeib M (2012). Phosphorus-containing fluorinated organics: polyfluoroalkyl phosphoric acid diesters (diPAPs), perfluorophosphonates (PFPA), and perfluorophosphinates (PFPIAs) in residential indoor dust. *Environ Sci Technol*, 46(22):12575–82. doi:[10.1021/es303172p](https://doi.org/10.1021/es303172p) PMID:[23102111](https://pubmed.ncbi.nlm.nih.gov/23102111/)
- Diaz MJ, Chinje E, Kentish P, Jarnot B, George M, Gibson G (1994). Induction of cytochrome P4504A by the peroxisome proliferator perfluoro-n-octanoic acid. *Toxicology*, 86(1–2):109–22. doi:[10.1016/0300-483X\(94\)90056-6](https://doi.org/10.1016/0300-483X(94)90056-6) PMID:[8134918](https://pubmed.ncbi.nlm.nih.gov/8134918/)
- Dixon D, Reed CE, Moore AB, Gibbs-Flournoy EA, Hines EP, Wallace EA, et al. (2012). Histopathologic changes in the uterus, cervix and vagina of immature CD-1 mice exposed to low doses of perfluorooctanoic acid (PFOA) in a uterotrophic assay. *Reprod Toxicol*, 33(4):506–12. doi:[10.1016/j.reprotox.2011.10.011](https://doi.org/10.1016/j.reprotox.2011.10.011) PMID:[22146484](https://pubmed.ncbi.nlm.nih.gov/22146484/)
- DuPont (2010). Quarterly MOU status report #17 phase II monitoring/sampling work plan DuPont Washington works (OPPT-2004-0113 PFOA site-related environmental assessment program). Newark (DE): URS Corporation.
- ECHA (2013). Agreement of the Member State Committee on the identification of pentadecafluorooctanoic (PFOA) as a Substance of Very High Concern. Helsinki: European Chemicals Agency. Available from: <http://echa.europa.eu/documents/10162/86f13df6-a078-475c-b0b2-2eb9536ebc5d>, accessed 15 September 2014.
- EFSA (2008). Perfluorooctanesulfonate (PFOS), perfluorooctanoic acid (PFOA) and their salts. Scientific Opinion of the Panel on Contaminants in the Food Chain (Question No. EFSA-Q-2004–163, adopted on 21 February 2008). Parma, Italy: European Food Safety Authority. *The EFSA Journal*, 653:1–131.
- Elcombe CR, Elcombe BM, Foster JR, Farrar DG, Jung R, Chang SC, et al. (2010). Hepatocellular hypertrophy and cell proliferation in Sprague-Dawley rats following dietary exposure to ammonium perfluorooctanoate occurs through increased activation of the xenosensor nuclear receptors PPAR $\alpha$  and CAR/PXR. *Arch Toxicol*, 84(10):787–98. doi:[10.1007/s00204-010-0572-2](https://doi.org/10.1007/s00204-010-0572-2) PMID:[20614104](https://pubmed.ncbi.nlm.nih.gov/20614104/)
- Elcombe CR, Wolf CR, Westwood D (2013). United States Patent Application Publication. Compositions comprising perfluorooctanoic acid. Pub. No. US 2013/0029928.
- Emmett EA, Shofer FS, Zhang H, Freeman D, Desai C, Shaw LM (2006). Community exposure to perfluorooctanoate: relationships between serum concentrations and exposure sources. *J Occup Environ Med*, 48(8):759–70. doi:[10.1097/01.jom.0000232486.07658.74](https://doi.org/10.1097/01.jom.0000232486.07658.74) PMID:[16902368](https://pubmed.ncbi.nlm.nih.gov/16902368/)
- Enomoto A, Endou H (2005). Roles of organic anion transporters (OATs) and a urate transporter (URAT1) in the pathophysiology of human disease. *Clin Exp Nephrol*, 9(3):195–205. doi:[10.1007/s10157-005-0368-5](https://doi.org/10.1007/s10157-005-0368-5) PMID:[16189627](https://pubmed.ncbi.nlm.nih.gov/16189627/)



- Environment Canada (2012). Screening assessment report. Perfluorooctanoic acid, its salts, and its precursors. Environment Canada, Health Canada. Available from: <https://www.ec.gc.ca/ese-ees/default.asp?lang=En&n=370AB133-1>, accessed 25 May 2016.
- EPA (1981). Attachments to letter to C. Auer dated May 25, 2000. An assay of cell transformation and cytotoxicity in C3H10T½ clonal cell line for the test chemical T-2942 CoC. Garry VF, Nelson RL (authors). Minneapolis, MN: Environmental Pathology Laboratory, Stone Research Laboratories. United States Environmental Protection Agency Administrative Record 226-0428.
- EPA (2009a). Method 537. Determination of selected perfluorinated alkyl acids in drinking water by solid phase extraction and liquid chromatography/tandem mass spectrometry (LC/MS/MS). Version 1.1. EPA Document No. EPA/600/R-08/092. Cincinnati (OH): National Exposure Research Laboratory, United States Environmental Protection Agency.
- EPA (2009b). Provisional health advisories for perfluorooctanoic acid (PFOA) and perfluorooctane sulfonate (PFOS). 8 January 2009. Available from: <https://www.epa.gov/sites/production/files/2015-09/documents/pfoa-pfos-provisional.pdf>, accessed 25 May 2016.
- EPA (2014). Health effects document for perfluorooctanoic acid (PFOA). EPA Document No. 822R14001. Washington (DC): Office of Water, Health and Ecological Criteria Division, United States Environmental Protection Agency. Available from: [http://peerreview.versar.com/epa/pfoa/pdf/Health-Effects-Documents-for-Perfluorooctanoic-Acid-\(PFOA\).pdf](http://peerreview.versar.com/epa/pfoa/pdf/Health-Effects-Documents-for-Perfluorooctanoic-Acid-(PFOA).pdf), accessed 15 September 2014.
- Ericson I, Martí-Cid R, Nadal M, Van Bavel B, Lindström G, Domingo JL (2008). Human exposure to perfluorinated chemicals through the diet: intake of perfluorinated compounds in foods from the Catalan (Spain) market. *J Agric Food Chem*, 56(5):1787–94. doi:10.1021/jf0732408 PMID:18251500
- Eriksen KT, Raaschou-Nielsen O, Sørensen M, Roursgaard M, Loft S, Møller P (2010). Genotoxic potential of the perfluorinated chemicals PFOA, PFOS, PFBS, PFNA and PFHxA in human HepG2 cells. *Mutat Res*, 700(1–2):39–43. doi:10.1016/j.mrgentox.2010.04.024 PMID:20451658
- Eriksen KT, Sørensen M, McLaughlin JK, Lipworth L, Tjønneland A, Overvad K, et al. (2009). Perfluorooctanoate and perfluorooctanesulfonate plasma levels and risk of cancer in the general Danish population. *J Natl Cancer Inst*, 101(8):605–9. doi:10.1093/jnci/djp041 PMID:19351918
- Fasano WJ, Kennedy GL, Szostek B, Farrar DG, Ward RJ, Haroun L, et al. (2005). Penetration of ammonium perfluorooctanoate through rat and human skin in vitro. *Drug Chem Toxicol*, 28(1):79–90. doi:10.1081/DCT-39707 PMID:15720037
- Fenton SE, Reiner JL, Nakayama SF, Delinsky AD, Stanko JP, Hines EP, et al. (2009). Analysis of PFOA in dosed CD-1 mice. Part 2. Disposition of PFOA in tissues and fluids from pregnant and lactating mice and their pups. *Reprod Toxicol*, 27(3–4):365–72. doi:10.1016/j.reprotox.2009.02.012 PMID:19429407
- Fernández Freire P, Pérez Martín JM, Herrero O, Peropadre A, de la Peña E, Hazen MJ (2008). In vitro assessment of the cytotoxic and mutagenic potential of perfluorooctanoic acid. *Toxicol In Vitro*, 22(5):1228–33. doi:10.1016/j.tiv.2008.04.004 PMID:18499391
- Florentin A, Deblonde T, Diguio N, Hautemaniere A, Hartemann P (2011). Impacts of two perfluorinated compounds (PFOS and PFOA) on human hepatoma cells: cytotoxicity but no genotoxicity? *Int J Hyg Environ Health*, 214(6):493–9. doi:10.1016/j.ijheh.2011.05.010 PMID:21676652
- Frisbee SJ, Brooks AP Jr, Maher A, et al. (2009). The C8 health project: design, methods, and participants. *Environ Health Perspect*, 117:1873–1882. doi:10.1289/ehp.0800379 PMID:20049206
- Fromme H, Midasch O, Twardella D, Angerer J, Boehmer S, Liebl B (2007). Occurrence of perfluorinated substances in an adult German population in southern Bavaria. *Int Arch Occup Environ Health*, 80(4):313–9. doi:10.1007/s00420-006-0136-1 PMID:16915390
- Fromme H, Tittlemier SA, Völkel W, Wilhelm M, Twardella D (2009). Perfluorinated compounds—exposure assessment for the general population in Western countries. *Int J Hyg Environ Health*, 212(3):239–70. doi:10.1016/j.ijheh.2008.04.007 PMID:18565792
- Gallo V, Leonardi G, Genser B, Lopez-Espinosa MJ, Frisbee SJ, Karlsson L, et al. (2012). Serum perfluorooctanoate (PFOA) and perfluorooctane sulfonate (PFOS) concentrations and liver function biomarkers in a population with elevated PFOA exposure. *Environ Health Perspect*, 120(5):655–60. doi:10.1289/ehp.1104436 PMID:22289616
- Gibson SJ, Johnson JD (1979). Absorption of FC-143–14C in rats after a single oral dose. St. Paul, MN: Riker Laboratories, Inc., Subsidiary of 3M. Washington (DC): USEPA Public Docket AR-226–0455.
- Gilliland FD, Mandel JS (1993). Mortality among employees of a perfluorooctanoic acid production plant. *J Occup Med*, 35(9):950–4. doi:10.1097/00043764-199309000-00020 PMID:8229349
- Glynn A, Berger U, Bignert A, Ullah S, Aune M, Lignell S, et al. (2012). Perfluorinated alkyl acids in blood serum from primiparous women in Sweden: serial sampling during pregnancy and nursing, and temporal trends 1996–2010. *Environ Sci Technol*, 46(16):9071–9. doi:10.1021/es301168c PMID:22770559
- Goecke CM, Jarnot BM, Reo NV (1992). A comparative toxicological investigation of perfluorocarboxylic acids in rats by fluorine-19 NMR spectroscopy. *Chem*

- Res Toxicol*, 5(4):512–9. doi:[10.1021/tx00028a009](https://doi.org/10.1021/tx00028a009) PMID:[1391617](https://pubmed.ncbi.nlm.nih.gov/1391617/)
- Griesbacher T, Pommer V, Schuligoi R, Tiran B, Peskar BA (2008). Anti-inflammatory actions of perfluorooctanoic acid and peroxisome proliferator-activated receptors (PPAR) alpha and gamma in experimental acute pancreatitis. *Int Immunopharmacol*, 8(2):325–9. doi:[10.1016/j.intimp.2007.08.005](https://doi.org/10.1016/j.intimp.2007.08.005) PMID:[18182248](https://pubmed.ncbi.nlm.nih.gov/18182248/)
- Griffith FD, Long JE (1980). Animal toxicity studies with ammonium perfluorooctanoate. *Am Ind Hyg Assoc J*, 41(8):576–83. doi:[10.1080/15298668091425301](https://doi.org/10.1080/15298668091425301) PMID:[6773404](https://pubmed.ncbi.nlm.nih.gov/6773404/)
- Gruber L, Schlummer J, Ungewib J, Wolz G, Moller A, Weise N, et al. (2007). Analysis of sub-ppb levels of perfluorooctanoic acid (PFOA) and perfluorooctanesulfonate (PFOS) in food and fish. *Organohalogen Compd*, 69:142–5.
- Guruge KS, Yeung LW, Yamanaka N, Miyazaki S, Lam PK, Giesy JP, et al. (2006). Gene expression profiles in rat liver treated with perfluorooctanoic acid (PFOA). *Toxicol Sci*, 89(1):93–107. doi:[10.1093/toxsci/kfj011](https://doi.org/10.1093/toxsci/kfj011) PMID:[16221955](https://pubmed.ncbi.nlm.nih.gov/16221955/)
- Hagenaars A, Vergauwen L, Benoot D, Laukens K, Knäpen D (2013). Mechanistic toxicity study of perfluorooctanoic acid in zebrafish suggests mitochondrial dysfunction to play a key role in PFOA toxicity. *Chemosphere*, 91(6):844–56. doi:[10.1016/j.chemosphere.2013.01.056](https://doi.org/10.1016/j.chemosphere.2013.01.056) PMID:[23427857](https://pubmed.ncbi.nlm.nih.gov/23427857/)
- Han X, Nabb DL, Russell MH, Kennedy GL, Rickard RW (2012). Renal elimination of perfluorocarboxylates (PFCAs). *Chem Res Toxicol*, 25(1):35–46. doi:[10.1021/tx200363w](https://doi.org/10.1021/tx200363w) PMID:[21985250](https://pubmed.ncbi.nlm.nih.gov/21985250/)
- Han X, Snow TA, Kemper RA, Jepson GW (2003). Binding of perfluorooctanoic acid to rat and human plasma proteins. *Chem Res Toxicol*, 16(6):775–81. doi:[10.1021/tx034005w](https://doi.org/10.1021/tx034005w) PMID:[12807361](https://pubmed.ncbi.nlm.nih.gov/12807361/)
- Hanhijärvi H, Ophaug RH, Singer L (1982). The sex-related difference in perfluorooctanoate excretion in the rat. *Proc Soc Exp Biol Med*, 171(1):50–5. doi:[10.3181/00379727-171-41476](https://doi.org/10.3181/00379727-171-41476) PMID:[7145938](https://pubmed.ncbi.nlm.nih.gov/7145938/)
- Hanhijärvi H, Ylinen M, Haaranen T, Nevalainen T (1988). A Proposed Species Difference in the Renal Excretion of Perfluorooctanoic Acid in the Beagle Dog and Rat. In: Beynen AC, Solleveld HA, editors. New developments in biosciences: Their implications for laboratory animal science. Dordrecht, The Netherlands: Martinus Nijhoff Publishers, 409–412.
- Harada K, Saito N, Inoue K, Yoshinaga T, Watanabe T, Sasaki S, et al. (2004). The influence of time, sex and geographic factors on levels of perfluorooctane sulfonate and perfluorooctanoate in human serum over the last 25 years. *J Occup Health*, 46(2):141–7. doi:[10.1539/joh.46.141](https://doi.org/10.1539/joh.46.141) PMID:[15090689](https://pubmed.ncbi.nlm.nih.gov/15090689/)
- Harada KH, Hashida S, Kaneko T, Takenaka K, Minata M, Inoue K, et al. (2007). Biliary excretion and cerebrospinal fluid partition of perfluorooctanoate and perfluorooctane sulfonate in humans. *Environ Toxicol Pharmacol*, 24(2):134–9. doi:[10.1016/j.etap.2007.04.003](https://doi.org/10.1016/j.etap.2007.04.003) PMID:[21783801](https://pubmed.ncbi.nlm.nih.gov/21783801/)
- Hardell E, Kärman A, van Bavel B, Bao J, Carlberg M, Hardell L (2014). Case-control study on perfluorinated alkyl acids (PFAAs) and the risk of prostate cancer. *Environ Int*, 63:35–9. doi:[10.1016/j.envint.2013.10.005](https://doi.org/10.1016/j.envint.2013.10.005) PMID:[24246240](https://pubmed.ncbi.nlm.nih.gov/24246240/)
- Hardisty JF, Willson GA, Brown WR, McConnell EE, Frame SR, Gaylor DW, et al. (2010). Pathology working group review and evaluation of proliferative lesions of mammary gland tissues in female rats fed ammonium perfluorooctanoate (APFO) in the diet for 2 years. *Drug Chem Toxicol*, 33(2):131–7. doi:[10.3109/01480541003667610](https://doi.org/10.3109/01480541003667610)
- Haug LS, Thomsen C, Becher G (2009). Time trends and the influence of age and gender on serum concentrations of perfluorinated compounds in archived human samples. *Environ Sci Technol*, 43(6):2131–6. doi:[10.1021/es802827u](https://doi.org/10.1021/es802827u) PMID:[19368225](https://pubmed.ncbi.nlm.nih.gov/19368225/)
- Hendricks JD, Meyers TR, Shelton DW (1984). Histological progression of hepatic neoplasia in rainbow trout (*Salmo gairdneri*). *Natl Cancer Inst Monogr*, 65:321–336. PMID:[6087143](https://pubmed.ncbi.nlm.nih.gov/6087143/)
- Henry ND, Fair PA (2013). Comparison of in vitro cytotoxicity, estrogenicity and anti-estrogenicity of triclosan, perfluorooctane sulfonate and perfluorooctanoic acid. *J Appl Toxicol*, 33(4):265–72. doi:[10.1002/jat.1736](https://doi.org/10.1002/jat.1736) PMID:[21935973](https://pubmed.ncbi.nlm.nih.gov/21935973/)
- Hinderliter PM (2003). Perfluorooctanoic acid: relationship between repeated inhalation exposures and plasma PFOA concentration in the rat. Haskell Laboratory for Health and Environmental Sciences. Study No. DuPont-12944, November 5, 2003 (as cited in SIAR, 2006).
- Hinderliter PM, Han X, Kennedy GL, Butenhoff JL (2006). Age effect on perfluorooctanoate (PFOA) plasma concentration in post-weaning rats following oral gavage with ammonium perfluorooctanoate (APFO). *Toxicology*, 225(2–3):195–203. doi:[10.1016/j.tox.2006.06.002](https://doi.org/10.1016/j.tox.2006.06.002) PMID:[16857306](https://pubmed.ncbi.nlm.nih.gov/16857306/)
- Hinderliter PM, Mylchreest E, Gannon SA, Butenhoff JL, Kennedy GL Jr (2005). Perfluorooctanoate: Placental and lactational transport pharmacokinetics in rats. *Toxicology*, 211(1–2):139–48. doi:[10.1016/j.tox.2005.03.010](https://doi.org/10.1016/j.tox.2005.03.010) PMID:[15863257](https://pubmed.ncbi.nlm.nih.gov/15863257/)
- Hölzer J, Midasch O, Rauchfuss K, Kraft M, Reupert R, Angerer J, et al. (2008). Biomonitoring of perfluorinated compounds in children and adults exposed to perfluorooctanoate-contaminated drinking water. *Environ Health Perspect*, 116(5):651–7. doi:[10.1289/ehp.11064](https://doi.org/10.1289/ehp.11064) PMID:[18470314](https://pubmed.ncbi.nlm.nih.gov/18470314/)
- HSDB (2014) Bethesda, MD: National Library of Medicine (US), Division of Specialized Information Services. 1986 - [cited 2014 Feb 20]. Available from: <http://toxnet.nlm.nih.gov>

- [nlm.nih.gov/cgi-bin/sis/htmlgen?HSDB](http://nlm.nih.gov/cgi-bin/sis/htmlgen?HSDB), accessed 15 September 2014.
- Hundley SG, Sarrif AM, Kennedy GL Jr (2006). Absorption, distribution, and excretion of ammonium perfluorooctanoate (APFO) after oral administration to various species. *Drug Chem Toxicol*, 29(2):137–45. doi:[10.1080/01480540600561361](https://doi.org/10.1080/01480540600561361) PMID:[16707323](https://pubmed.ncbi.nlm.nih.gov/16707323/)
- IFA (2014). Perfluorooctanoic acid. GESTIS Substance Database, ZVG No. 493012. Sankt Augustin, Germany: The Institute for Occupational Safety and Health of the German Social Accident Insurance. Available from: [http://gestis-en.itrust.de/nxt/gateway.dll/gestis-en/000000.xml?f=templates\\$fn=default.htm\\$3.0](http://gestis-en.itrust.de/nxt/gateway.dll/gestis-en/000000.xml?f=templates$fn=default.htm$3.0).
- Innes KE, Wimsatt JH, Frisbee S, Ducatman AM (2014). Inverse association of colorectal cancer prevalence to serum levels of perfluorooctane sulfonate (PFOS) and perfluorooctanoate (PFOA) in a large Appalachian population. *BMC Cancer*, 14(1):45. doi:[10.1186/1471-2407-14-45](https://doi.org/10.1186/1471-2407-14-45) PMID:[24468211](https://pubmed.ncbi.nlm.nih.gov/24468211/)
- Ishibashi H, Ishida H, Matsuoka M, Tominaga N, Arizono K (2007). Estrogenic effects of fluorotelomer alcohols for human estrogen receptor isoforms alpha and beta in vitro. *Biol Pharm Bull*, 30(7):1358–9. doi:[10.1248/bpb.30.1358](https://doi.org/10.1248/bpb.30.1358) PMID:[17603182](https://pubmed.ncbi.nlm.nih.gov/17603182/)
- Jahnke A, Berger U (2009). Trace analysis of per- and polyfluorinated alkyl substances in various matrices-how do current methods perform? *J Chromatogr A*, 1216(3):410–21. doi:[10.1016/j.chroma.2008.08.098](https://doi.org/10.1016/j.chroma.2008.08.098) PMID:[18817914](https://pubmed.ncbi.nlm.nih.gov/18817914/)
- Johnson JD, Gibson SJ, Ober RE (1984). Cholestyramine-enhanced fecal elimination of carbon-14 in rats after administration of ammonium [<sup>14</sup>C]perfluorooctanoate or potassium [<sup>14</sup>C]perfluorooctanesulfonate. *Fundam Appl Toxicol*, 4(6):972–6. doi:[10.1016/0272-0590\(84\)90235-5](https://doi.org/10.1016/0272-0590(84)90235-5) PMID:[6519377](https://pubmed.ncbi.nlm.nih.gov/6519377/)
- Johnson JD, Ober RE (1980). Extent and route of excretion and tissue distribution of total carbon-14 in male and female rats after a single IV dose of FC-143–14C. EPA Public Docket AR-226–457. St Paul (MN): Riker Laboratories Inc.
- Kaiser MA, Dawson BJ, Barton CA, Botelho MA (2010). Understanding potential exposure sources of perfluorinated carboxylic acids in the workplace. *Ann Occup Hyg*, 54(8):915–22. doi:[10.1093/annhyg/meq066](https://doi.org/10.1093/annhyg/meq066) PMID:[20974675](https://pubmed.ncbi.nlm.nih.gov/20974675/)
- Kannan K, Corsolini S, Falandysz J, Fillmann G, Kumar KS, Loganathan BG, et al. (2004). Perfluorooctanesulfonate and related fluorochemicals in human blood from several countries. *Environ Sci Technol*, 38(17):4489–95. doi:[10.1021/es0493446](https://doi.org/10.1021/es0493446) PMID:[15461154](https://pubmed.ncbi.nlm.nih.gov/15461154/)
- Kärrman A, Domingo JL, Llebaria X, Nadal M, Bigas E, van Bavel B, et al. (2010). Biomonitoring perfluorinated compounds in Catalonia, Spain: concentrations and trends in human liver and milk samples. *Environ Sci Pollut Res Int*, 17(3):750–8. doi:[10.1007/s11356-009-0178-5](https://doi.org/10.1007/s11356-009-0178-5) PMID:[19458971](https://pubmed.ncbi.nlm.nih.gov/19458971/)
- Kärrman A, Ericson I, van Bavel B, Darnerud PO, Aune M, Glynn A, et al. (2007). Exposure of perfluorinated chemicals through lactation: levels of matched human milk and serum and a temporal trend, 1996–2004, in Sweden. *Environ Health Perspect*, 115(2):226–30. doi:[10.1289/ehp.9491](https://doi.org/10.1289/ehp.9491) PMID:[17384769](https://pubmed.ncbi.nlm.nih.gov/17384769/)
- Kärrman A, Mueller JF, van Bavel B, Harden F, Toms LML, Lindström G (2006). Levels of 12 perfluorinated chemicals in pooled Australian serum, collected 2002–2003, in relation to age, gender, and region. *Environ Sci Technol*, 40(12):3742–8. doi:[10.1021/es060301u](https://doi.org/10.1021/es060301u) PMID:[16830536](https://pubmed.ncbi.nlm.nih.gov/16830536/)
- Kato K, Wong LY, Jia LT, Kuklennyik Z, Calafat AM (2011). Trends in exposure to polyfluoroalkyl chemicals in the U.S. Population: 1999–2008. *Environ Sci Technol*, 45(19):8037–45. doi:[10.1021/es1043613](https://doi.org/10.1021/es1043613) PMID:[21469664](https://pubmed.ncbi.nlm.nih.gov/21469664/)
- Kavlock R, Chandler K, Houck K, Hunter S, Judson R, Kleinstreuer N, et al. (2012). Update on EPA's ToxCast program: providing high throughput decision support tools for chemical risk management. *Chem Res Toxicol*, 25(7):1287–302. doi:[10.1021/tx3000939](https://doi.org/10.1021/tx3000939) PMID:[22519603](https://pubmed.ncbi.nlm.nih.gov/22519603/)
- Kawamoto K, Oashi T, Oami K, Liu W, Jin Y, Saito N, et al. (2010). Perfluorooctanoic acid (PFOA) but not perfluorooctane sulfonate (PFOS) showed DNA damage in comet assay on *Paramecium caudatum*. *J Toxicol Sci*, 35(6):835–41. doi:[10.2131/jts.35.835](https://doi.org/10.2131/jts.35.835) PMID:[21139333](https://pubmed.ncbi.nlm.nih.gov/21139333/)
- Kawashima Y, Kobayashi H, Miura H, Kozuka H (1995). Characterization of hepatic responses of rat to administration of perfluorooctanoic and perfluorodecanoic acids at low levels. *Toxicology*, 99(3):169–78. doi:[10.1016/0300-483X\(95\)03027-D](https://doi.org/10.1016/0300-483X(95)03027-D) PMID:[7610463](https://pubmed.ncbi.nlm.nih.gov/7610463/)
- Kawashima Y, Suzuki S, Kozuka H, Sato M, Suzuki Y (1994). Effects of prolonged administration of perfluorooctanoic acid on hepatic activities of enzymes which detoxify peroxide and xenobiotic in the rat. *Toxicology*, 93(2–3):85–97. doi:[10.1016/0300-483X\(94\)90070-1](https://doi.org/10.1016/0300-483X(94)90070-1) PMID:[7974521](https://pubmed.ncbi.nlm.nih.gov/7974521/)
- Kemper RA, Jepson GW (2003). Pharmacokinetics of perfluorooctanoic acid in male and female rats. In: Annual Meeting of the Society of Toxicology. Salt Lake City (UT); p.148.
- Kemper RA, Nabb DL (2005). In vitro studies in microsomes from rat and human liver, kidney, and intestine suggest that perfluorooctanoic acid is not a substrate for microsomal UDP-glucuronosyltransferases. *Drug Chem Toxicol*, 28(3):281–7. doi:[10.1081/DCT-200064468](https://doi.org/10.1081/DCT-200064468) PMID:[16051554](https://pubmed.ncbi.nlm.nih.gov/16051554/)
- Kennedy GL Jr (1985). Dermal toxicity of ammonium perfluorooctanoate. *Toxicol Appl Pharmacol*, 81(2):348–55. doi:[10.1016/0041-008X\(85\)90172-3](https://doi.org/10.1016/0041-008X(85)90172-3) PMID:[4060160](https://pubmed.ncbi.nlm.nih.gov/4060160/)
- Kennedy GL Jr, Butenhoff JL, Olsen GW, O'Connor JC, Seacat AM, Perkins RG, et al. (2004). The toxicology

- of perfluorooctanoate. *Crit Rev Toxicol*, 34(4):351–84. doi:[10.1080/10408440490464705](https://doi.org/10.1080/10408440490464705) PMID:[15328768](https://pubmed.ncbi.nlm.nih.gov/15328768/)
- Kennedy GL Jr, Hall GT, Brittelli MR, Barnes JR, Chen HC (1986). Inhalation toxicity of ammonium perfluorooctanoate. *Food Chem Toxicol*, 24(12):1325–9. doi:[10.1016/0278-6915\(86\)90066-9](https://doi.org/10.1016/0278-6915(86)90066-9) PMID:[3804135](https://pubmed.ncbi.nlm.nih.gov/3804135/)
- Kerstner-Wood C, Coward L, Gorman G (2003). Protein binding of perfluorobutane sulfonate, perfluorohexane sulfonate, perfluorooctane sulfonate, and perfluorooctanoate to plasma (human, rat, and monkey), and various human-derived plasma protein fractions Birmingham (AL): Southern Research Institute.
- Kikuchi R, Kusahara H, Hattori N, Kim I, Shiota K, Gonzalez FJ, et al. (2007). Regulation of tissue-specific expression of the human and mouse urate transporter 1 gene by hepatocyte nuclear factor 1 alpha/beta and DNA methylation. *Mol Pharmacol*, 72(6):1619–25. doi:[10.1124/mol.107.039701](https://doi.org/10.1124/mol.107.039701) PMID:[17855651](https://pubmed.ncbi.nlm.nih.gov/17855651/)
- Kim SK, Kho YL, Shoeib M, Kim KS, Kim KR, Park JE, et al. (2011b). Occurrence of perfluorooctanoate and perfluorooctanesulfonate in the Korean water system: implication to water intake exposure. *Environ Pollut*, 159(5):1167–73. doi:[10.1016/j.envpol.2011.02.004](https://doi.org/10.1016/j.envpol.2011.02.004) PMID:[21376440](https://pubmed.ncbi.nlm.nih.gov/21376440/)
- Kim SK, Lee KT, Kang CS, Tao L, Kannan K, Kim KR, et al. (2011a). Distribution of perfluorochemicals between sera and milk from the same mothers and implications for prenatal and postnatal exposures. *Environ Pollut*, 159(1):169–74. doi:[10.1016/j.envpol.2010.09.008](https://doi.org/10.1016/j.envpol.2010.09.008) PMID:[20932617](https://pubmed.ncbi.nlm.nih.gov/20932617/)
- Knox SS, Jackson T, Frisbee SJ, Javins B, Ducatman AM (2011). Perfluorocarbon exposure, gender and thyroid function in the C8 Health Project. *J Toxicol Sci*, 36(4):403–10. doi:[10.2131/jts.36.403](https://doi.org/10.2131/jts.36.403) PMID:[21804304](https://pubmed.ncbi.nlm.nih.gov/21804304/)
- Kojo A, Hanhijärvi H, Ylinen M, Kosma VM (1986). Toxicity and kinetics of perfluoro-octanoic acid in the Wistar rat. *Arch Toxicol Suppl*, 9:465–8. doi:[10.1007/978-3-642-71248-7\\_96](https://doi.org/10.1007/978-3-642-71248-7_96) PMID:[3468930](https://pubmed.ncbi.nlm.nih.gov/3468930/)
- Kubwabo C, Stewart B, Zhu J, Marro L (2005). Occurrence of perfluorosulfonates and other perfluorochemicals in dust from selected homes in the city of Ottawa, Canada. *J Environ Monit*, 7(11):1074–8. doi:[10.1039/b507731c](https://doi.org/10.1039/b507731c) PMID:[16252056](https://pubmed.ncbi.nlm.nih.gov/16252056/)
- Kudo N, Katakura M, Sato Y, Kawashima Y (2002). Sex hormone-regulated renal transport of perfluorooctanoic acid. *Chem Biol Interact*, 139(3):301–16. doi:[10.1016/S0009-2797\(02\)00006-6](https://doi.org/10.1016/S0009-2797(02)00006-6) PMID:[11879818](https://pubmed.ncbi.nlm.nih.gov/11879818/)
- Kudo N, Kawashima Y (2003). Toxicity and toxicokinetics of perfluorooctanoic acid in humans and animals. *J Toxicol Sci*, 28(2):49–57. doi:[10.2131/jts.28.49](https://doi.org/10.2131/jts.28.49) PMID:[12820537](https://pubmed.ncbi.nlm.nih.gov/12820537/)
- Kudo N, Suzuki E, Katakura M, Ohmori K, Noshiro R, Kawashima Y (2001). Comparison of the elimination between perfluorinated fatty acids with different carbon chain length in rats. *Chem Biol Interact*, 134(2):203–16. doi:[10.1016/S0009-2797\(01\)00155-7](https://doi.org/10.1016/S0009-2797(01)00155-7) PMID:[11311214](https://pubmed.ncbi.nlm.nih.gov/11311214/)
- Kuklenyik Z, Needham LL, Calafat AM (2005). Measurement of 18 perfluorinated organic acids and amides in human serum using on-line solid-phase extraction. *Anal Chem*, 77(18):6085–91. doi:[10.1021/ac0506711](https://doi.org/10.1021/ac0506711) PMID:[16159145](https://pubmed.ncbi.nlm.nih.gov/16159145/)
- Kuklenyik Z, Reich JA, Tully JS, Needham LL, Calafat AM (2004). Automated solid-phase extraction and measurement of perfluorinated organic acids and amides in human serum and milk. *Environ Sci Technol*, 38(13):3698–704. doi:[10.1021/es040332u](https://doi.org/10.1021/es040332u) PMID:[15296323](https://pubmed.ncbi.nlm.nih.gov/15296323/)
- Kuslikis BI, Vanden Heuvel JP, Peterson RE (1992). Lack of evidence for perfluorodecanoyl- or perfluorooctanoyl-coenzyme A formation in male and female rats. *J Biochem Toxicol*, 7(1):25–9. doi:[10.1002/jbt.2570070106](https://doi.org/10.1002/jbt.2570070106) PMID:[1588571](https://pubmed.ncbi.nlm.nih.gov/1588571/)
- Lau C (2012). Perfluorinated compounds. *EXS*, 101:47–86. doi:[10.1007/978-3-7643-8340-4\\_3](https://doi.org/10.1007/978-3-7643-8340-4_3) PMID:[22945566](https://pubmed.ncbi.nlm.nih.gov/22945566/)
- Lawlor TE (1995). Mutagenicity test with T-6342 in the Salmonella-Escherichia coli/mammalian-microsome reverse mutation assay. Laboratory Number: 17073–0–409. Corning Hazleton Inc., Vienna, VA. 3M Corp. St. Paul (MN): U.S. Environmental Protection Agency Administrative Record 226–0436 (as cited in SIAR, 2006).
- Lawlor TE (1996). Mutagenicity test with T-6564 in the Salmonella-Escherichia coli/mammalian-microsome reverse mutation assay with a confirmatory assay. Corning Hazleton Inc. Final Report. CHV Study No: 17750–0–409R. September 13, 1996. U.S. Environmental Protection Agency Administrative Record 226–0432 (as cited in SIAR, 2006).
- Lee H, Mabury SA (2011). A pilot survey of legacy and current commercial fluorinated chemicals in human sera from United States donors in 2009. *Environ Sci Technol*, 45(19):8067–74. doi:[10.1021/es200167q](https://doi.org/10.1021/es200167q) PMID:[21486041](https://pubmed.ncbi.nlm.nih.gov/21486041/)
- Lee SS, Pineau T, Drago J, Lee EJ, Owens JW, Kroetz DL, et al. (1995). Targeted disruption of the alpha isoform of the peroxisome proliferator-activated receptor gene in mice results in abolishment of the pleiotropic effects of peroxisome proliferators. *Mol Cell Biol*, 15(6):3012–22. PMID:[7539101](https://pubmed.ncbi.nlm.nih.gov/7539101/)
- Leonard RC, Kreckmann KH, Sakr CJ, Symons JM (2008). Retrospective cohort mortality study of workers in a polymer production plant including a reference population of regional workers. *Ann Epidemiol*, 18(1):15–22. doi:[10.1016/j.annepidem.2007.06.011](https://doi.org/10.1016/j.annepidem.2007.06.011) PMID:[17900928](https://pubmed.ncbi.nlm.nih.gov/17900928/)
- Lin CY, Lin LY, Chiang CK, Wang WJ, Su YN, Hung KY, et al. (2010). Investigation of the associations between low-dose serum perfluorinated chemicals and liver enzymes in US adults. *Am J Gastroenterol*, 105(6):1354–63. doi:[10.1038/ajg.2009.707](https://doi.org/10.1038/ajg.2009.707) PMID:[20010922](https://pubmed.ncbi.nlm.nih.gov/20010922/)
- Liu C, Du Y, Zhou B (2007b). Evaluation of estrogenic activities and mechanism of action of perfluorinated chemicals determined by vitellogenin induction in

- primary cultured tilapia hepatocytes. *Aquat Toxicol*, 85(4):267–77. doi:[10.1016/j.aquatox.2007.09.009](https://doi.org/10.1016/j.aquatox.2007.09.009) PMID:[17980923](https://pubmed.ncbi.nlm.nih.gov/17980923/)
- Liu C, Yu K, Shi X, Wang J, Lam PK, Wu RS, et al. (2007a). Induction of oxidative stress and apoptosis by PFOS and PFOA in primary cultured hepatocytes of freshwater tilapia (*Oreochromis niloticus*). *Aquat Toxicol*, 82(2):135–43. doi:[10.1016/j.aquatox.2007.02.006](https://doi.org/10.1016/j.aquatox.2007.02.006) PMID:[17374408](https://pubmed.ncbi.nlm.nih.gov/17374408/)
- Llorca M, Farré M, Picó Y, Teijón ML, Alvarez JG, Barceló D (2010). Infant exposure of perfluorinated compounds: levels in breast milk and commercial baby food. *Environ Int*, 36(6):584–92. doi:[10.1016/j.envint.2010.04.016](https://doi.org/10.1016/j.envint.2010.04.016) PMID:[20494442](https://pubmed.ncbi.nlm.nih.gov/20494442/)
- Lopez-Espinosa MJ, Mondal D, Armstrong B, Bloom MS, Fletcher T (2012). Thyroid function and perfluoroalkyl acids in children living near a chemical plant. *Environ Health Perspect*, 120(7):1036–41. doi:[10.1289/ehp.1104370](https://doi.org/10.1289/ehp.1104370) PMID:[22453676](https://pubmed.ncbi.nlm.nih.gov/22453676/)
- Lou I, Wambaugh JF, Lau C, Hanson RG, Lindstrom AB, Strynar MJ, et al. (2009). Modeling single and repeated dose pharmacokinetics of PFOA in mice. *Toxicol Sci*, 107(2):331–41. doi:[10.1093/toxsci/kfn234](https://doi.org/10.1093/toxsci/kfn234) PMID:[19005225](https://pubmed.ncbi.nlm.nih.gov/19005225/)
- Luebker DJ, Hansen KJ, Bass NM, Butenhoff JL, Seacat AM (2002). Interactions of fluorochemicals with rat liver fatty acid-binding protein. *Toxicology*, 176(3):175–85. doi:[10.1016/S0300-483X\(02\)00081-1](https://doi.org/10.1016/S0300-483X(02)00081-1) PMID:[12093614](https://pubmed.ncbi.nlm.nih.gov/12093614/)
- Lundin JI, Alexander BH, Olsen GW, Church TR (2009). Ammonium perfluorooctanoate production and occupational mortality. *Epidemiology*, 20(6):921–8. doi:[10.1097/EDE.0b013e3181b5f395](https://doi.org/10.1097/EDE.0b013e3181b5f395) PMID:[19797969](https://pubmed.ncbi.nlm.nih.gov/19797969/)
- Lupton SJ, Huwe JK, Smith DJ, Dearfield KL, Johnston JJ (2012). Absorption and excretion of <sup>14</sup>C-perfluorooctanoic acid (PFOA) in Angus cattle (*Bos taurus*). *J Agric Food Chem*, 60(4):1128–34. doi:[10.1021/jf2042505](https://doi.org/10.1021/jf2042505) PMID:[22224442](https://pubmed.ncbi.nlm.nih.gov/22224442/)
- Macon MB, Villanueva LR, Tatum-Gibbs K, Zehr RD, Strynar MJ, Stanko JP, et al. (2011). Prenatal perfluorooctanoic acid exposure in CD-1 mice: low-dose developmental effects and internal dosimetry. *Toxicol Sci*, 122(1):134–45. doi:[10.1093/toxsci/kfr076](https://doi.org/10.1093/toxsci/kfr076) PMID:[21482639](https://pubmed.ncbi.nlm.nih.gov/21482639/)
- Maras M, Vanparys C, Muylle F, Robbens J, Berger U, Barber JL, et al. (2006). Estrogen-like properties of fluorotelomer alcohols as revealed by mcf-7 breast cancer cell proliferation. *Environ Health Perspect*, 114(1):100–5. doi:[10.1289/ehp.8149](https://doi.org/10.1289/ehp.8149) PMID:[16393665](https://pubmed.ncbi.nlm.nih.gov/16393665/)
- Martin MT, Dix DJ, Judson RS, Kavlock RJ, Reif DM, Richard AM, et al. (2010). Impact of environmental chemicals on key transcription regulators and correlation to toxicity end points within EPA's ToxCast program, 23(3):578–590.
- Melzer D, Rice N, Depledge MH, Henley WE, Galloway TS (2010). Association between serum perfluorooctanoic acid (PFOA) and thyroid disease in the U.S. National Health and Nutrition Examination Survey. *Environ Health Perspect*, 118(5):686–92. doi:[10.1289/ehp.0901584](https://doi.org/10.1289/ehp.0901584) PMID:[20089479](https://pubmed.ncbi.nlm.nih.gov/20089479/)
- Midasch O, Drexler H, Hart N, Beckmann MW, Angerer J (2007). Transplacental exposure of neonates to perfluorooctanesulfonate and perfluorooctanoate: a pilot study. *Int Arch Occup Environ Health*, 80(7):643–8. doi:[10.1007/s00420-006-0165-9](https://doi.org/10.1007/s00420-006-0165-9) PMID:[17219182](https://pubmed.ncbi.nlm.nih.gov/17219182/)
- Minata M, Harada KH, Kärrman A, Hitomi T, Hirosawa M, Murata M, et al. (2010). Role of peroxisome proliferator-activated receptor-alpha in hepatobiliary injury induced by ammonium perfluorooctanoate in mouse liver. *Ind Health*, 48(1):96–107. doi:[10.2486/indhealth.48.96](https://doi.org/10.2486/indhealth.48.96) PMID:[20160413](https://pubmed.ncbi.nlm.nih.gov/20160413/)
- Monroy R, Morrison K, Teo K, Atkinson S, Kubwabo C, Stewart B, et al. (2008). Serum levels of perfluoroalkyl compounds in human maternal and umbilical cord blood samples. *Environ Res*, 108(1):56–62. doi:[10.1016/j.envres.2008.06.001](https://doi.org/10.1016/j.envres.2008.06.001) PMID:[18649879](https://pubmed.ncbi.nlm.nih.gov/18649879/)
- Moriwaki H, Takatah Y, Arakawa R (2003). Concentrations of perfluorooctane sulfonate (PFOS) and perfluorooctanoic acid (PFOA) in vacuum cleaner dust collected in Japanese homes. *J Environ Monit*, 5(5):753–7. doi:[10.1039/b307147m](https://doi.org/10.1039/b307147m) PMID:[14587845](https://pubmed.ncbi.nlm.nih.gov/14587845/)
- Murli H (1995). Mutagenicity test on T-6342 in an in vivo mouse micronucleus assay. Vienna (VA): Corning Hazleton Inc. Study No. 17073–0–455, December 14, 1995. U.S. Environmental Protection Agency Administrative Record 226–0435 (as cited in SIAR, 2006).
- Murli H (1996a). Mutagenicity test on T-6342 measuring chromosome aberrations in human whole blood lymphocytes with a confirmatory assay with multiple harvests. Vienna (VA): Corning-Hazleton, Inc. Study No. 17073–0–449CO, November 1, 1996. U.S. Environmental Protection Agency Administrative Record 226–0433 (as cited in SIAR, 2006).
- Murli H (1996b). Mutagenicity test on T-6564 measuring chromosomal aberrations in Chinese Hamster Ovary (CHO) cells with a confirmatory assay with multiple harvests. Vienna (VA): Corning-Hazleton, Inc. Study No. 17750–0–437CO, September 16, 1996. U.S. Environmental Protection Agency Administrative Record 226–0431 (as cited in SIAR, 2006).
- Murli H (1996c). Mutagenicity test on T-6342 measuring chromosomal aberrations in Chinese Hamster Ovary (CHO) cells: with a confirmatory assay with multiple harvests. Vienna (VA): Corning-Hazleton, Inc. Study No. 17073–0–437CO, September 16, 1996. U.S. Environmental Protection Agency Administrative Record 226–0434 (as cited in SIAR, 2006).
- Murli H (1996d). Mutagenicity test on T-6564 in an in vivo mouse micronucleus assay. Vienna (VA): Corning-Hazleton, Inc. Study number 17750–0–455, November 1, 1996. U.S. Environmental Protection

- Agency Administrative Record 226–0430 (as cited in SIAR, 2006).
- Nakagawa H, Hirata T, Terada T, Jutabha P, Miura D, Harada KH, et al. (2008). Roles of organic anion transporters in the renal excretion of perfluorooctanoic acid. *Basic Clin Pharmacol Toxicol*, 103(1):1–8. doi:[10.1111/j.1742-7843.2007.00155.x](https://doi.org/10.1111/j.1742-7843.2007.00155.x) PMID:[18373647](https://pubmed.ncbi.nlm.nih.gov/18373647/)
- Nakagawa H, Terada T, Harada KH, Hitomi T, Inoue K, Inui K, et al. (2009). Human organic anion transporter hOAT4 is a transporter of perfluorooctanoic acid. *Basic Clin Pharmacol Toxicol*, 105(2):136–8. doi:[10.1111/j.1742-7843.2009.00409.x](https://doi.org/10.1111/j.1742-7843.2009.00409.x) PMID:[19371258](https://pubmed.ncbi.nlm.nih.gov/19371258/)
- Nakagawa T, Ramdhan DH, Tanaka N, Naito H, Tamada H, Ito Y, et al. (2012). Modulation of ammonium perfluorooctanoate-induced hepatic damage by genetically different PPAR $\alpha$  in mice. *Arch Toxicol*, 86(1):63–74. doi:[10.1007/s00204-011-0704-3](https://doi.org/10.1007/s00204-011-0704-3) PMID:[21499893](https://pubmed.ncbi.nlm.nih.gov/21499893/)
- Nakamura T, Ito Y, Yanagiba Y, Ramdhan DH, Kono Y, Naito H, et al. (2009). Microgram-order ammonium perfluorooctanoate may activate mouse peroxisome proliferator-activated receptor alpha, but not human PPAR $\alpha$ . *Toxicology*, 265(1–2):27–33. doi:[10.1016/j.tox.2009.09.004](https://doi.org/10.1016/j.tox.2009.09.004) PMID:[19751795](https://pubmed.ncbi.nlm.nih.gov/19751795/)
- Nakata A, Katsumata T, Iwasaki Y, Ito R, Saito K, Izumi S, et al. (2007). Measurement of perfluorinated compounds in human milk and house dust. *Organohalogen Compd*, 69:2844–6.
- Nielsen CJ (2012). PFOA Isomers, Salts and Precursors, Literature study and evaluation of physico-chemical properties. CTCC, Dept of Chemistry, Univ of Oslo. Available from: <http://www.miljodirektoratet.no/old/klif/publikasjoner/2944/ta2944.pdf>, accessed 15 September 2014.
- Nilsson R, Beije B, Pr at V, Erixon K, Ramel C (1991). On the mechanism of the hepatocarcinogenicity of peroxisome proliferators. *Chem Biol Interact*, 78(2):235–50. doi:[10.1016/0009-2797\(91\)90017-2](https://doi.org/10.1016/0009-2797(91)90017-2) PMID:[2040027](https://pubmed.ncbi.nlm.nih.gov/2040027/)
- Noker P (2003). A pharmacokinetic study of potassium perfluorooctanoate in the cynomolgus monkey. Southern Research Institute Study ID: 99214. South Research Institute, submitted to USEPA Public Docket AR-226–1362.
- NOTOX (2000). Evaluation of the ability of T-7524 to induce chromosome aberrations in cultured peripheral human lymphocytes. NOTOX Project Number 292062. Hertogenbosch, The Netherlands (as cited in SIAR, 2006).
- O'Malley KD, Ebbins KL (1981). Repeat application 28 day percutaneous absorption study with T-2618CoC in albino rabbits. Riker Laboratories, St. Paul (MN). U.S. Environmental Protection Agency Administrative Record 226–0446. (as cited in SIAR, 2006).
- O'Shea SH, Schwarz J, Kosyk O, Ross PK, Ha MJ, Wright FA, et al. (2011). In vitro screening for population variability in chemical toxicity. *Toxicol Sci*, 119(2):398–407. doi:[10.1093/toxsci/kfq322](https://doi.org/10.1093/toxsci/kfq322) PMID:[20952501](https://pubmed.ncbi.nlm.nih.gov/20952501/)
- Oda Y, Nakayama S, Harada KH, Koizumi A (2007). Negative results of *umu* genotoxicity test of fluorotelomer alcohols and perfluorinated alkyl acids. *Environ Health Prev Med*, 12(5):217–9. doi:[10.1265/ehpm.12.217](https://doi.org/10.1265/ehpm.12.217) PMID:[21432084](https://pubmed.ncbi.nlm.nih.gov/21432084/)
- Ohmori K, Kudo N, Katayama K, Kawashima Y (2003). Comparison of the toxicokinetics between perfluorocarboxylic acids with different carbon chain length. *Toxicology*, 184(2–3):135–40. doi:[10.1016/S0300-483X\(02\)00573-5](https://doi.org/10.1016/S0300-483X(02)00573-5) PMID:[12499116](https://pubmed.ncbi.nlm.nih.gov/12499116/)
- Olsen GW, Burriss JM, Ehresman DJ, Froehlich JW, Seacat AM, Butenhoff JL, et al. (2007). Half-life of serum elimination of perfluorooctanesulfonate, perfluorohexanesulfonate, and perfluorooctanoate in retired fluorochemical production workers. *Environ Health Perspect*, 115(9):1298–305. doi:[10.1289/ehp.10009](https://doi.org/10.1289/ehp.10009) PMID:[17805419](https://pubmed.ncbi.nlm.nih.gov/17805419/)
- Olsen GW, Hansen KJ, Stevenson LA, Burriss JM, Mandel JH (2003b). Human donor liver and serum concentrations of perfluorooctanesulfonate and other perfluorochemicals. *Environ Sci Technol*, 37(5):888–91. doi:[10.1021/es020955c](https://doi.org/10.1021/es020955c) PMID:[12666917](https://pubmed.ncbi.nlm.nih.gov/12666917/)
- Olsen GW, Huang HY, Helzlsouer KJ, Hansen KJ, Butenhoff JL, Mandel JH (2005). Historical comparison of perfluorooctanesulfonate, perfluorooctanoate, and other fluorochemicals in human blood. *Environ Health Perspect*, 113(5):539–45. doi:[10.1289/ehp.7544](https://doi.org/10.1289/ehp.7544) PMID:[15866760](https://pubmed.ncbi.nlm.nih.gov/15866760/)
- Olsen GW, Logan PW, Hansen KJ, et al. (2003a). An occupational exposure assessment of a perfluorooctanesulfonyl fluoride production site: biomonitoring. *AIHA J (Fairfax, Va)*, 64:651–659. doi:[10.1080/15428110308984859](https://doi.org/10.1080/15428110308984859) PMID:[14521435](https://pubmed.ncbi.nlm.nih.gov/14521435/)
- Olsen GW, Zobel LR (2007). Assessment of lipid, hepatic, and thyroid parameters with serum perfluorooctanoate (PFOA) concentrations in fluorochemical production workers. *Int Arch Occup Environ Health*, 81(2):231–46. doi:[10.1007/s00420-007-0213-0](https://doi.org/10.1007/s00420-007-0213-0) PMID:[17605032](https://pubmed.ncbi.nlm.nih.gov/17605032/)
- Ophaug RH, Singer L (1980). Metabolic Handling of perfluorooctanoic acid in rats. *Proc Soc Exp Biol Med*, 163(1):19–23. doi:[10.3181/00379727-163-40715](https://doi.org/10.3181/00379727-163-40715) PMID:[7352143](https://pubmed.ncbi.nlm.nih.gov/7352143/)
- Panaretakis T, Shabalina IG, Grand r D, Shoshan MC, DePierre JW (2001). Reactive oxygen species and mitochondria mediate the induction of apoptosis in human hepatoma HepG2 cells by the rodent peroxisome proliferator and hepatocarcinogen, perfluorooctanoic acid. *Toxicol Appl Pharmacol*, 173(1):56–64. doi:[10.1006/taap.2001.9159](https://doi.org/10.1006/taap.2001.9159) PMID:[11350215](https://pubmed.ncbi.nlm.nih.gov/11350215/)
- Paustenbach DJ, Panko JM, Scott PK, Unice KM (2007). A methodology for estimating human exposure to perfluorooctanoic acid (PFOA): a retrospective exposure assessment of a community (1951–2003). *J Toxicol Environ Health A*, 70(1):28–57. doi:[10.1080/15287390600748815](https://doi.org/10.1080/15287390600748815) PMID:[17162497](https://pubmed.ncbi.nlm.nih.gov/17162497/)

- Pérez F, Nadal M, Navarro-Ortega A, Fàbrega F, Domingo JL, Barceló D, et al. (2013). Accumulation of perfluoroalkyl substances in human tissues. *Environ Int*, 59:354–62. doi:[10.1016/j.envint.2013.06.004](https://doi.org/10.1016/j.envint.2013.06.004) PMID:[23892228](https://pubmed.ncbi.nlm.nih.gov/23892228/)
- Post GB, Cohn PD, Cooper KR (2012). Perfluorooctanoic acid (PFOA), an emerging drinking water contaminant: a critical review of recent literature. *Environ Res*, 116:93–117. doi:[10.1016/j.envres.2012.03.007](https://doi.org/10.1016/j.envres.2012.03.007) PMID:[22560884](https://pubmed.ncbi.nlm.nih.gov/22560884/)
- Prevedouros K, Cousins IT, Buck RC, Korzeniowski SH (2006). Sources, fate and transport of perfluorocarboxylates. *Environ Sci Technol*, 40(1):32–44. doi:[10.1021/es0512475](https://doi.org/10.1021/es0512475) PMID:[16433330](https://pubmed.ncbi.nlm.nih.gov/16433330/)
- Qazi MR, Bogdanska J, Butenhoff JL, Nelson BD, DePierre JW, Abedi-Valugerdi M (2009). High-dose, short-term exposure of mice to perfluorooctanesulfonate (PFOS) or perfluorooctanoate (PFOA) affects the number of circulating neutrophils differently, but enhances the inflammatory responses of macrophages to lipopolysaccharide (LPS) in a similar fashion. *Toxicology*, 262(3):207–14. doi:[10.1016/j.tox.2009.06.010](https://doi.org/10.1016/j.tox.2009.06.010) PMID:[19540903](https://pubmed.ncbi.nlm.nih.gov/19540903/)
- Quiñones O, Snyder SA (2009). Occurrence of perfluoroalkyl carboxylates and sulfonates in drinking water utilities and related waters from the United States. *Environ Sci Technol*, 43(24):9089–95. doi:[10.1021/es9024707](https://doi.org/10.1021/es9024707) PMID:[20000497](https://pubmed.ncbi.nlm.nih.gov/20000497/)
- Raleigh KK, Alexander BH, Olsen GW, et al. (2014). Mortality and cancer incidence in ammonium perfluorooctanoate production workers. *Occup Environ Med*, 71(7):500–6. doi:[10.1136/oemed-2014-102109](https://doi.org/10.1136/oemed-2014-102109) PMID:[24832944](https://pubmed.ncbi.nlm.nih.gov/24832944/)
- Ren H, Vallanat B, Nelson DM, Yeung LW, Guruge KS, Lam PK, et al. (2009). Evidence for the involvement of xenobiotic-responsive nuclear receptors in transcriptional effects upon perfluoroalkyl acid exposure in diverse species. *Reprod Toxicol*, 27(3–4):266–77. doi:[10.1016/j.reprotox.2008.12.011](https://doi.org/10.1016/j.reprotox.2008.12.011) PMID:[19162173](https://pubmed.ncbi.nlm.nih.gov/19162173/)
- Rosen MB, Abbott BD, Wolf DC, Corton JC, Wood CR, Schmid JE, et al. (2008a). Gene profiling in the livers of wild-type and PPARalpha-null mice exposed to perfluorooctanoic acid. *Toxicol Pathol*, 36(4):592–607. doi:[10.1177/0192623308318208](https://doi.org/10.1177/0192623308318208) PMID:[18467677](https://pubmed.ncbi.nlm.nih.gov/18467677/)
- Rosen MB, Lee JS, Ren H, Vallanat B, Liu J, Waalkes MP, et al. (2008b). Toxicogenomic dissection of the perfluorooctanoic acid transcript profile in mouse liver: evidence for the involvement of nuclear receptors PPAR alpha and CAR. *Toxicol Sci*, 103(1):46–56. doi:[10.1093/toxsci/kfn025](https://doi.org/10.1093/toxsci/kfn025) PMID:[18281256](https://pubmed.ncbi.nlm.nih.gov/18281256/)
- Sadhu D (2002). CHO/HGPRT forward mutation assay – ISO (T6.889.7). Toxicon Corporation, Bedford, MA. Report No. 01–7019–G1, March 28, 2002. U.S. Environmental Protection Agency Administrative Record 226–1101 (as cited in SIAR, 2006).
- Sakr CJ, Leonard RC, Kreckmann KH, Slade MD, Cullen MR (2007). Longitudinal study of serum lipids and liver enzymes in workers with occupational exposure to ammonium perfluorooctanoate. *J Occup Environ Med*, 49(8):872–9. doi:[10.1097/JOM.0b013e318124a93f](https://doi.org/10.1097/JOM.0b013e318124a93f) PMID:[17693785](https://pubmed.ncbi.nlm.nih.gov/17693785/)
- SEER (2014). United States Surveillance, Epidemiology and End Results. Available from: <http://seer.cancer.gov>, accessed June 3, 2014.
- Shabalina IG, Panaretakis T, Bergstrand A, DePierre JW (1999). Effects of the rodent peroxisome proliferator and hepatocarcinogen, perfluorooctanoic acid, on apoptosis in human hepatoma HepG2 cells. *Carcinogenesis*, 20(12):2237–46. doi:[10.1093/carcin/20.12.2237](https://doi.org/10.1093/carcin/20.12.2237) PMID:[10590214](https://pubmed.ncbi.nlm.nih.gov/10590214/)
- Shankar A, Xiao J, Ducatman A (2011a). Perfluoroalkyl chemicals and chronic kidney disease in US adults. *Am J Epidemiol*, 174(8):893–900. doi:[10.1093/aje/kwr171](https://doi.org/10.1093/aje/kwr171) PMID:[21873601](https://pubmed.ncbi.nlm.nih.gov/21873601/)
- Shankar A, Xiao J, Ducatman A (2011b). Perfluoroalkyl chemicals and elevated serum uric acid in US adults. *Clin Epidemiol*, 3:251–8. doi:[10.2147/CLEP.S21677](https://doi.org/10.2147/CLEP.S21677) PMID:[22003309](https://pubmed.ncbi.nlm.nih.gov/22003309/)
- Shin HM, Vieira VM, Ryan PB, et al. (2011b). Environmental fate and transport modeling for perfluorooctanoic acid emitted from the Washington Works Facility in West Virginia. *Environ Sci Technol*, 45:1435–1442. doi:[10.1021/es102769t](https://doi.org/10.1021/es102769t) PMID:[21226527](https://pubmed.ncbi.nlm.nih.gov/21226527/)
- Shin HM, Vieira VM, Ryan PB, Steenland K, Bartell SM (2011a). Retrospective exposure estimation and predicted versus observed serum perfluorooctanoic acid concentrations for participants in the C8 Health Project. *Environ Health Perspect*, 119(12):1760–5. doi:[10.1289/ehp.1103729](https://doi.org/10.1289/ehp.1103729) PMID:[21813367](https://pubmed.ncbi.nlm.nih.gov/21813367/)
- Sinclair E, Kim SK, Akinleye HB, Kannan K (2007). Quantitation of gas-phase perfluoroalkyl surfactants and fluorotelomer alcohols released from nonstick cookware and microwave popcorn bags. *Environ Sci Technol*, 41(4):1180–5. doi:[10.1021/es062377w](https://doi.org/10.1021/es062377w) PMID:[17593716](https://pubmed.ncbi.nlm.nih.gov/17593716/)
- Sipes NS, Martin MT, Kothiyi P, Reif DM, Judson RS, Richard AM, et al. (2013). Profiling 976 ToxCast chemicals across 331 enzymatic and receptor signalling assays. *Chem Res Toxicol*, 26(6):878–95. doi:[10.1021/tx400021f](https://doi.org/10.1021/tx400021f) PMID:[23611293](https://pubmed.ncbi.nlm.nih.gov/23611293/)
- Skutlarek D, Exner M, Färber H (2006). Perfluorinated surfactants in surface and drinking waters. *Environ Sci Pollut Res Int*, 13(5):299–307. doi:[10.1065/espr2006.07.326](https://doi.org/10.1065/espr2006.07.326) PMID:[17067024](https://pubmed.ncbi.nlm.nih.gov/17067024/)
- Sleeuwenhoek A, Cherrie JW (2012). Exposure assessment of tetrafluoroethylene and ammonium perfluorooctanoate 1951–2002. *J Environ Monit*, 14(3):775–81. doi:[10.1039/c2em10930a](https://doi.org/10.1039/c2em10930a) PMID:[22322341](https://pubmed.ncbi.nlm.nih.gov/22322341/)
- So MK, Yamashita N, Taniyasu S, Jiang Q, Giesy JP, Chen K, et al. (2006). Health risks in infants associated with exposure to perfluorinated compounds in human breast milk from Zhoushan, China. *Environ Sci Technol*, 40(9):2924–9. doi:[10.1021/es060031f](https://doi.org/10.1021/es060031f) PMID:[16719092](https://pubmed.ncbi.nlm.nih.gov/16719092/)

- Sohlenius AK, Andersson K, Bergstrand A, Spydevold O, De Pierre JW (1994). Effects of perfluorooctanoic acid—a potent peroxisome proliferator in rat—on Morris hepatoma 7800C1 cells, a rat cell line. *Biochim Biophys Acta*, 1213(1):63–74. doi:[10.1016/0005-2760\(94\)90223-2](https://doi.org/10.1016/0005-2760(94)90223-2) PMID:[8011682](https://pubmed.ncbi.nlm.nih.gov/8011682/)
- Sohlenius AK, Andersson K, DePierre JW (1992a). The effects of perfluoro-octanoic acid on hepatic peroxisome proliferation and related parameters show no sex-related differences in mice. *Biochem J*, 285(Pt 3):779–83. PMID:[1497616](https://pubmed.ncbi.nlm.nih.gov/1497616/)
- Sohlenius AK, Lundgren B, DePierre JW (1992b). Perfluorooctanoic acid has persistent effects on peroxisome proliferation and related parameters in mouse liver. *J Biochem Toxicol*, 7(4):205–12. doi:[10.1002/jbt.2570070403](https://doi.org/10.1002/jbt.2570070403) PMID:[1293309](https://pubmed.ncbi.nlm.nih.gov/1293309/)
- Son HY, Kim SH, Shin HI, Bae HI, Yang JH (2008). Perfluorooctanoic acid-induced hepatic toxicity following 21-day oral exposure in mice. *Arch Toxicol*, 82(4):239–46. doi:[10.1007/s00204-007-0246-x](https://doi.org/10.1007/s00204-007-0246-x) PMID:[17874065](https://pubmed.ncbi.nlm.nih.gov/17874065/)
- Steenland K, Savitz DA, Fletcher T (2014). Commentary: class action lawsuits: can they advance epidemiologic research? *Epidemiology*, 25(2):167–9. doi:[10.1097/EDE.0000000000000067](https://doi.org/10.1097/EDE.0000000000000067) PMID:[24487199](https://pubmed.ncbi.nlm.nih.gov/24487199/)
- Steenland K, Tinker S, Shankar A, Ducatman A (2010). Association of perfluorooctanoic acid (PFOA) and perfluorooctane sulfonate (PFOS) with uric acid among adults with elevated community exposure to PFOA. *Environ Health Perspect*, 118(2):229–33. doi:[10.1289/ehp.0900940](https://doi.org/10.1289/ehp.0900940) PMID:[20123605](https://pubmed.ncbi.nlm.nih.gov/20123605/)
- Steenland K, Woskie S (2012). Cohort mortality study of workers exposed to perfluorooctanoic acid. *Am J Epidemiol*, 176(10):909–17. doi:[10.1093/aje/kws171](https://doi.org/10.1093/aje/kws171) PMID:[23079607](https://pubmed.ncbi.nlm.nih.gov/23079607/)
- Strynar MJ, Lindstrom AB (2008). Perfluorinated compounds in house dust from Ohio and North Carolina, USA. *Environ Sci Technol*, 42(10):3751–6. doi:[10.1021/es7032058](https://doi.org/10.1021/es7032058) PMID:[18546718](https://pubmed.ncbi.nlm.nih.gov/18546718/)
- Takacs ML, Abbott BD (2007). Activation of mouse and human peroxisome proliferator-activated receptors (alpha, beta/delta, gamma) by perfluorooctanoic acid and perfluorooctane sulfonate. *Toxicol Sci*, 95(1):108–17. doi:[10.1093/toxsci/kfl135](https://doi.org/10.1093/toxsci/kfl135) PMID:[17047030](https://pubmed.ncbi.nlm.nih.gov/17047030/)
- Takagi A, Sai K, Umemura T, Hasegawa R, Kurokawa Y (1991). Short-term exposure to the peroxisome proliferators, perfluorooctanoic acid and perfluorodecanoic acid, causes significant increase of 8-hydroxydeoxyguanosine in liver DNA of rats. *Cancer Lett*, 57(1):55–60. doi:[10.1016/0304-3835\(91\)90063-N](https://doi.org/10.1016/0304-3835(91)90063-N) PMID:[2025879](https://pubmed.ncbi.nlm.nih.gov/2025879/)
- Tao L, Kannan K, Wong CM, Arcaro KF, Butenhoff JL (2008). Perfluorinated compounds in human milk from Massachusetts, U.S.A. *Environ Sci Technol*, 42(8):3096–101. doi:[10.1021/es702789k](https://doi.org/10.1021/es702789k) PMID:[18497172](https://pubmed.ncbi.nlm.nih.gov/18497172/)
- Taylor BK, Dadia N, Yang CB, Krishnan S, Badr M (2002). Peroxisome proliferator-activated receptor agonists inhibit inflammatory edema and hyperalgesia. *Inflammation*, 26(3):121–7. doi:[10.1023/A:1015500531113](https://doi.org/10.1023/A:1015500531113)
- Taylor BK, Kriedt C, Nagalingam S, Dadia N, Badr M (2005). Central administration of perfluorooctanoic acid inhibits cutaneous inflammation. *Inflamm Res*, 54(6):235–42. doi:[10.1007/s00011-005-1350-0](https://doi.org/10.1007/s00011-005-1350-0)
- Thomsen C, Haug LS, Stigum H, Frøshaug M, Broadwell SL, Becher G (2010). Changes in concentrations of perfluorinated compounds, polybrominated diphenyl ethers, and polychlorinated biphenyls in Norwegian breast-milk during twelve months of lactation. *Environ Sci Technol*, 44(24):9550–6. doi:[10.1021/es1021922](https://doi.org/10.1021/es1021922) PMID:[21090747](https://pubmed.ncbi.nlm.nih.gov/21090747/)
- Thottassery J, Winberg L, Youssef J, Cunningham M, Badr M (1992). Regulation of perfluorooctanoic acid–induced peroxisomal enzyme activities and hepatocellular growth by adrenal hormones. *Hepatology*, 15(2):316–22. doi:[10.1002/hep.1840150223](https://doi.org/10.1002/hep.1840150223) PMID:[1735536](https://pubmed.ncbi.nlm.nih.gov/1735536/)
- Tice RR, Austin CP, Kavlock RJ, Bucher JR (2013). Improving the human hazard characterization of chemicals: a Tox21 update. *Environ Health Perspect*, 121(7):756–65. doi:[10.1289/ehp.1205784](https://doi.org/10.1289/ehp.1205784) PMID:[23603828](https://pubmed.ncbi.nlm.nih.gov/23603828/)
- Tilton SC, Orner GA, Benninghoff AD, Carpenter HM, Hendricks JD, Pereira CB, et al. (2008). Genomic profiling reveals an alternate mechanism for hepatic tumor promotion by perfluorooctanoic acid in rainbow trout. *Environ Health Perspect*, 116(8):1047–55. doi:[10.1289/ehp.11190](https://doi.org/10.1289/ehp.11190) PMID:[18709148](https://pubmed.ncbi.nlm.nih.gov/18709148/)
- Tittlemeier SA, Pepper K, Seymour C, Moisey J, Bronson R, Cao XL, et al. (2007). Dietary exposure of Canadians to perfluorinated carboxylates and perfluorooctane sulfonate via consumption of meat, fish, fast foods, and food items prepared in their packaging. *J Agric Food Chem*, 55(8):3203–10. doi:[10.1021/jf0634045](https://doi.org/10.1021/jf0634045) PMID:[17381114](https://pubmed.ncbi.nlm.nih.gov/17381114/)
- Toms LM, Calafat AM, Kato K, Thompson J, Harden F, Hobson P, et al. (2009). Polyfluoroalkyl chemicals in pooled blood serum from infants, children, and adults in Australia. *Environ Sci Technol*, 43(11):4194–9. doi:[10.1021/es900272u](https://doi.org/10.1021/es900272u) PMID:[19569351](https://pubmed.ncbi.nlm.nih.gov/19569351/)
- ToxCast (2014). ToxCast and Tox21 data. Publicly available through the ICSS dashboard. Available from: <http://actor.epa.gov/dashboard/>, accessed 13 May 2015.
- Trudel D, Horowitz L, Wormuth M, Scheringer M, Cousins IT, Hungerbühler K (2008). Estimating consumer exposure to PFOS and PFOA. *Risk Anal*, 28(2):251–69. doi:[10.1111/j.1539-6924.2008.01017.x](https://doi.org/10.1111/j.1539-6924.2008.01017.x) PMID:[18419647](https://pubmed.ncbi.nlm.nih.gov/18419647/)
- UL (2014). Norway bans use of PFOA in consumer products. Northbrook (IL): UL. [Online news item]. Available from: <http://industries.ul.com/news/norway-bans-use-of-pfoa-in-consumer-products>, accessed 9 September 2015.
- Uy-Yu N, Kawashima Y, Kozuka H (1990). Comparative studies on sex-related difference in biochemical



- responses of livers to perfluorooctanoic acid between rats and mice. *Biochem Pharmacol*, 39(9):1492–5. doi:[10.1016/0006-2952\(90\)90434-M](https://doi.org/10.1016/0006-2952(90)90434-M) PMID:[2334448](https://pubmed.ncbi.nlm.nih.gov/2334448/)
- Vanden Heuvel JP, Davis JW 2nd, Sommers R, Peterson RE (1992b). Renal excretion of perfluorooctanoic acid in male rats: inhibitory effect of testosterone. *J Biochem Toxicol*, 7(1):31–6. doi:[10.1002/jbt.2570070107](https://doi.org/10.1002/jbt.2570070107) PMID:[1375295](https://pubmed.ncbi.nlm.nih.gov/1375295/)
- Vanden Heuvel JP, Kuslikis BI, Peterson RE (1992a). Covalent binding of perfluorinated fatty acids to proteins in the plasma, liver and testes of rats. *Chem Biol Interact*, 82(3):317–28. doi:[10.1016/0009-2797\(92\)90003-4](https://doi.org/10.1016/0009-2797(92)90003-4) PMID:[1606626](https://pubmed.ncbi.nlm.nih.gov/1606626/)
- Vanden Heuvel JP, Kuslikis BI, Van Rafelghem MJ, Peterson RE (1991). Tissue distribution, metabolism, and elimination of perfluorooctanoic acid in male and female rats. *J Biochem Toxicol*, 6(2):83–92. doi:[10.1002/jbt.2570060202](https://doi.org/10.1002/jbt.2570060202) PMID:[1941903](https://pubmed.ncbi.nlm.nih.gov/1941903/)
- Vieira V, Hoffman K, Fletcher T (2013a). Assessing the spatial distribution of perfluorooctanoic acid exposure via public drinking water pipes using geographic information systems. *Environ Health Toxicol*, 28:e2013009. doi:[10.5620/eh.2013.28.e2013009](https://doi.org/10.5620/eh.2013.28.e2013009) PMID:[24010064](https://pubmed.ncbi.nlm.nih.gov/24010064/)
- Vieira VM, Hoffman K, Shin HM, Weinberg JM, Webster TF, Fletcher T (2013b). Perfluorooctanoic acid exposure and cancer outcomes in a contaminated community: a geographic analysis. *Environ Health Perspect*, 121(3):318–23. doi:[10.1289/ehp.1205829](https://doi.org/10.1289/ehp.1205829) PMID:[23308854](https://pubmed.ncbi.nlm.nih.gov/23308854/)
- Vieira VM, Howard GJ, Gallagher LG, Fletcher T (2010). Geocoding rural addresses in a community contaminated by PFOA: a comparison of methods. *Environ Health*, 9:18. doi:[10.1186/1476-069X-9-18](https://doi.org/10.1186/1476-069X-9-18) PMID:[20406495](https://pubmed.ncbi.nlm.nih.gov/20406495/)
- Völkel W, Genzel-Boroviczeny O, Demmelmair H, Gebauer C, Koletzko B, Twardella D, et al. (2008). Perfluorooctane sulphonate (PFOS) and perfluorooctanoic acid (PFOA) in human breast milk: results of a pilot study. *Int J Hyg Environ Health*, 211(3-4):440–6. doi:[10.1016/j.ijheh.2007.07.024](https://doi.org/10.1016/j.ijheh.2007.07.024) PMID:[17870667](https://pubmed.ncbi.nlm.nih.gov/17870667/)
- von Ehrenstein OS, Fenton SE, Kato K, Kuklennyik Z, Calafat AM, Hines EP (2009). Polyfluoroalkyl chemicals in the serum and milk of breastfeeding women. *Reprod Toxicol*, 27(3-4):239–45. doi:[10.1016/j.reprotox.2009.03.001](https://doi.org/10.1016/j.reprotox.2009.03.001) PMID:[19429402](https://pubmed.ncbi.nlm.nih.gov/19429402/)
- Walters MW, Wallace KB (2010). Urea cycle gene expression is suppressed by PFOA treatment in rats. *Toxicol Lett*, 197(1):46–50. doi:[10.1016/j.toxlet.2010.04.027](https://doi.org/10.1016/j.toxlet.2010.04.027) PMID:[20452409](https://pubmed.ncbi.nlm.nih.gov/20452409/)
- Wan YJ, Badr MZ (2006). Inhibition of carrageenan-induced cutaneous inflammation by PPAR agonists is dependent on hepatocyte-specific retinoid X receptor alpha. *PPAR Res*, 2006(ID96341):1–6. doi:[10.1155/PPAR/2006/96341](https://doi.org/10.1155/PPAR/2006/96341)
- Washington JW, Henderson WM, Ellington JJ, Jenkins TM, Evans JJ (2008). Analysis of perfluorinated carboxylic acids in soils II: optimization of chromatography and extraction. *J Chromatogr A*, 1181(1–2):21–32. doi:[10.1016/j.chroma.2007.12.042](https://doi.org/10.1016/j.chroma.2007.12.042) PMID:[18201708](https://pubmed.ncbi.nlm.nih.gov/18201708/)
- Watkins DJ, Josson J, Elston B, Bartell SM, Shin HM, Vieira VM, et al. (2013). Exposure to perfluoroalkyl acids and markers of kidney function among children and adolescents living near a chemical plant. *Environ Health Perspect*, 121(5):625–30. doi:[10.1289/ehp.1205838](https://doi.org/10.1289/ehp.1205838) PMID:[23482063](https://pubmed.ncbi.nlm.nih.gov/23482063/)
- Weaver YM, Ehresman DJ, Butenhoff JL, Hagenbuch B (2010). Roles of rat renal organic anion transporters in transporting perfluorinated carboxylates with different chain lengths. *Toxicol Sci*, 113(2):305–14. doi:[10.1093/toxsci/kfp275](https://doi.org/10.1093/toxsci/kfp275) PMID:[19915082](https://pubmed.ncbi.nlm.nih.gov/19915082/)
- Wei Y, Dai J, Liu M, Wang J, Xu M, Zha J, et al. (2007). Estrogen-like properties of perfluorooctanoic acid as revealed by expressing hepatic estrogen-responsive genes in rare minnows (*Gobiocypris rarus*). *Environ Toxicol Chem*, 26(11):2440–7. doi:[10.1897/07-008R1.1](https://doi.org/10.1897/07-008R1.1) PMID:[17941737](https://pubmed.ncbi.nlm.nih.gov/17941737/)
- Wei Y, Liu Y, Wang J, Tao Y, Dai J (2008). Toxicogenomic analysis of the hepatic effects of perfluorooctanoic acid on rare minnows (*Gobiocypris rarus*). *Toxicol Appl Pharmacol*, 226(3):285–97. doi:[10.1016/j.taap.2007.09.023](https://doi.org/10.1016/j.taap.2007.09.023) PMID:[17976672](https://pubmed.ncbi.nlm.nih.gov/17976672/)
- Weiss JM, Andersson PL, Lamoree MH, Leonards PEG, van Leeuwen SPJ, Hamers T (2009). Competitive binding of poly- and perfluorinated compounds to the thyroid hormone transport protein transthyretin. *Toxicol Sci*, 109(2):206–16. doi:[10.1093/toxsci/kfp055](https://doi.org/10.1093/toxsci/kfp055) PMID:[19293372](https://pubmed.ncbi.nlm.nih.gov/19293372/)
- Wen LL, Lin LY, Su TC, Chen PC, Lin CY (2013). Association between serum perfluorinated chemicals and thyroid function in U.S. adults: the National Health and Nutrition Examination Survey 2007–2010. *J Clin Endocrinol Metab*, 98(9):E1456–64. doi:[10.1210/jc.2013-1282](https://doi.org/10.1210/jc.2013-1282) PMID:[23864701](https://pubmed.ncbi.nlm.nih.gov/23864701/)
- Wilhelm M, Kraft M, Rauchfuss K, Hölzer J (2008). Assessment and management of the first German case of a contamination with perfluorinated compounds (PFC) in the Region Sauerland, North Rhine-Westphalia. *J Toxicol Environ Health A*, 71(11-12):725–33. doi:[10.1080/15287390801985216](https://doi.org/10.1080/15287390801985216) PMID:[18569570](https://pubmed.ncbi.nlm.nih.gov/18569570/)
- Williams DE (2012). The rainbow trout liver cancer model: Response to environmental chemicals and studies on promotion and chemoprevention. *Comp Biochem Physiol C Toxicol Pharmacol*, 155(1):121–7. doi:[10.1016/j.cbpc.2011.05.013](https://doi.org/10.1016/j.cbpc.2011.05.013)
- Williams DE, Bailey GS, Reddy A, Hendricks JD, Oganessian A, Orner GA, et al. (2003). The rainbow trout (*Oncorhynchus mykiss*) tumour model: Recent applications in low-dose exposures to tumour initiators and promoters. *Toxicol Pathol*, 31(Suppl.):58–61.
- Winquist A, Steenland K (2014). Perfluorooctanoic acid exposure and thyroid disease in community and worker

- cohorts. *Epidemiology*, 25(2):255–64. doi:[10.1097/EDE.000000000000040](https://doi.org/10.1097/EDE.000000000000040) PMID:[24407430](https://pubmed.ncbi.nlm.nih.gov/24407430/)
- Wolf CJ, Schmid JE, Lau C, Abbott BD (2012). Activation of mouse and human peroxisome proliferator-activated receptor- $\alpha$  (PPAR $\alpha$ ) by perfluoroalkyl acids (PFAAs): further investigation of C4–C12 compounds. *Reprod Toxicol*, 33(4):546–51. doi:[10.1016/j.reprotox.2011.09.009](https://doi.org/10.1016/j.reprotox.2011.09.009) PMID:[22107727](https://pubmed.ncbi.nlm.nih.gov/22107727/)
- Woskie SR, Gore R, Steenland K (2012). Retrospective exposure assessment of perfluorooctanoic acid serum concentrations at a fluoropolymer manufacturing plant. *Ann Occup Hyg*, 56(9):1025–37. doi:[10.1093/annhyg/mes023](https://doi.org/10.1093/annhyg/mes023) PMID:[22539556](https://pubmed.ncbi.nlm.nih.gov/22539556/)
- Xu G, Bhatnagar V, Wen G, Hamilton BA, Eraly SA, Nigam SK (2005). Analyses of coding region polymorphisms in apical and basolateral human organic anion transporter (OAT) genes [OAT1 (NKT), OAT2, OAT3, OAT4, URAT (RST)]. [OAT1 (NKT), OAT2, OAT3, OAT4, URAT (RST)]*Kidney Int*, 68(4):1491–9. doi:[10.1111/j.1523-1755.2005.00612.x](https://doi.org/10.1111/j.1523-1755.2005.00612.x) PMID:[16164626](https://pubmed.ncbi.nlm.nih.gov/16164626/)
- Yang C, Tan YS, Harkema JR, Haslam SZ (2009b). Differential effects of peripubertal exposure to perfluorooctanoic acid on mammary gland development in C57Bl/6 and Balb/c mouse strains. *Reprod Toxicol*, 27(3–4):299–306. doi:[10.1016/j.reprotox.2008.10.003](https://doi.org/10.1016/j.reprotox.2008.10.003) PMID:[19013232](https://pubmed.ncbi.nlm.nih.gov/19013232/)
- Yang CH, Glover KP, Han X (2009a). Organic anion transporting polypeptide (Oatp) 1a1-mediated perfluorooctanoate transport and evidence for a renal reabsorption mechanism of Oatp1a1 in renal elimination of perfluorocarboxylates in rats. *Toxicol Lett*, 190(2):163–71. doi:[10.1016/j.toxlet.2009.07.011](https://doi.org/10.1016/j.toxlet.2009.07.011) PMID:[19616083](https://pubmed.ncbi.nlm.nih.gov/19616083/)
- Yang CH, Glover KP, Han X (2010). Characterization of cellular uptake of perfluorooctanoate via organic anion-transporting polypeptide 1A2, organic anion transporter 4, and urate transporter 1 for their potential roles in mediating human renal reabsorption of perfluorocarboxylates. *Toxicol Sci*, 117(2):294–302. doi:[10.1093/toxsci/kfq219](https://doi.org/10.1093/toxsci/kfq219) PMID:[20639259](https://pubmed.ncbi.nlm.nih.gov/20639259/)
- Yang JH (2010). Perfluorooctanoic acid induces peroxisomal fatty acid oxidation and cytokine expression in the liver of male Japanese medaka (*Oryzias latipes*). *Chemosphere*, 81(4):548–52. doi:[10.1016/j.chemosphere.2010.06.028](https://doi.org/10.1016/j.chemosphere.2010.06.028) PMID:[20594573](https://pubmed.ncbi.nlm.nih.gov/20594573/)
- Yao X, Zhong L (2005). Genotoxic risk and oxidative DNA damage in HepG2 cells exposed to perfluorooctanoic acid. *Mutat Res*, 587(1–2):38–44. doi:[10.1016/j.mrgentox.2005.07.010](https://doi.org/10.1016/j.mrgentox.2005.07.010) PMID:[16219484](https://pubmed.ncbi.nlm.nih.gov/16219484/)
- Yeung LW, Guruge KS, Taniyasu S, Yamashita N, Angus PW, Herath CB (2013). Profiles of perfluoroalkyl substances in the liver and serum of patients with liver cancer and cirrhosis in Australia. *Ecotoxicol Environ Saf*, 96:139–46. doi:[10.1016/j.ecoenv.2013.06.006](https://doi.org/10.1016/j.ecoenv.2013.06.006) PMID:[23849467](https://pubmed.ncbi.nlm.nih.gov/23849467/)
- Yeung LW, Guruge KS, Yamanaka N, Miyazaki S, Lam PK (2007). Differential expression of chicken hepatic genes responsive to PFOA and PFOS. *Toxicology*, 237(1–3):111–25. doi:[10.1016/j.tox.2007.05.004](https://doi.org/10.1016/j.tox.2007.05.004) PMID:[17560707](https://pubmed.ncbi.nlm.nih.gov/17560707/)
- Ylinen M, Hanhijärvi H, Jaakonaho J, Peura P (1989). Stimulation by oestradiol of the urinary excretion of perfluorooctanoic acid in the male rat. *Pharmacol Toxicol*, 65(4):274–7. doi:[10.1111/j.1600-0773.1989.tb01172.x](https://doi.org/10.1111/j.1600-0773.1989.tb01172.x) PMID:[2587510](https://pubmed.ncbi.nlm.nih.gov/2587510/)
- Ylinen M, Kojo A, Hanhijärvi H, Peura P (1990). Disposition of perfluorooctanoic acid in the rat after single and subchronic administration. *Bull Environ Contam Toxicol*, 44(1):46–53. doi:[10.1007/BF01702360](https://doi.org/10.1007/BF01702360) PMID:[2306537](https://pubmed.ncbi.nlm.nih.gov/2306537/)
- Zhang W, Lin Z, Hu M, Wang X, Lian Q, Lin K, et al. (2011). Perfluorinated chemicals in blood of residents in Wenzhou, China. *Ecotoxicol Environ Saf*, 74(6):1787–93. doi:[10.1016/j.ecoenv.2011.04.027](https://doi.org/10.1016/j.ecoenv.2011.04.027) PMID:[21570120](https://pubmed.ncbi.nlm.nih.gov/21570120/)
- Zhao B, Chu Y, Hardy DO, Li XK, Ge RS (2010a). Inhibition of 3 $\beta$ - and 17 $\beta$ -hydroxysteroid dehydrogenase activities in rat Leydig cells by perfluorooctane acid. *J Steroid Biochem Mol Biol*, 118(1–2):13–7. doi:[10.1016/j.jsbmb.2009.09.010](https://doi.org/10.1016/j.jsbmb.2009.09.010) PMID:[19818404](https://pubmed.ncbi.nlm.nih.gov/19818404/)
- Zhao G, Wang J, Wang X, Chen S, Zhao Y, Gu F, et al. (2011). Mutagenicity of PFOA in mammalian cells: role of mitochondria-dependent reactive oxygen species. *Environ Sci Technol*, 45(4):1638–44. doi:[10.1021/es1026129](https://doi.org/10.1021/es1026129) PMID:[21194205](https://pubmed.ncbi.nlm.nih.gov/21194205/)
- Zhao Y, Tan YS, Haslam SZ, Yang C (2010b). Perfluorooctanoic acid effects on steroid hormone and growth factor levels mediate stimulation of peripubertal mammary gland development in C57BL/6 mice. *Toxicol Sci*, 115(1):214–24. doi:[10.1093/toxsci/kfq030](https://doi.org/10.1093/toxsci/kfq030) PMID:[20118188](https://pubmed.ncbi.nlm.nih.gov/20118188/)
- Zhao Y, Tan YS, Haslam SZ, Yang C (2010c). Perfluorooctanoic acid effects on steroid hormone and growth factor levels mediate stimulation of peripubertal mammary gland development in C57BL/6 mice. *Toxicol Sci*, 115(1):214–24. doi:[10.1093/toxsci/kfq030](https://doi.org/10.1093/toxsci/kfq030) PMID:[20118188](https://pubmed.ncbi.nlm.nih.gov/20118188/)